



Organize & Store

STARMARK[®]
C A B I N E T R Y



PICKUP Sam
@ 6
DINNER @ 5
• eggs
• milk
• Bread
XO



STARMARK®
CABINETS



UPPER OVEN TIMER 1 CLOCK TIMER 2 LOWER OVEN

START CONTINUE	CONV BAKE	CONV BROIL	BAKE BROIL	PROOF	CONV ROAST	CONV COOK	TEST CLEAN	1	2	3
	CONV TOAST	CONV TOAST	CONV TOAST	STOP	CONV TOAST	CONV TOAST	STOP	4	5	6
	CONV TOAST	CONV TOAST	CONV TOAST	STOP	CONV TOAST	CONV TOAST	STOP	7	8	9
								*	0	#

CANCEL
SECURE

CANCEL
SECURE

table of contents



Why create a zone? Because when you design cabinetry for a room based on the activities that happen frequently, you make the best use of available space and you make things easier on yourself—everything is one step away, or better yet, no steps away. Here are five examples:

- Create a **PLANNING ZONE** 4-7
- Create a **SET THE TABLE ZONE** 8-13
- Create a **MEAL PREP ZONE** 14-19
- Create a **CLEAN UP ZONE** 20-21
- Create a **DISPLAY ZONE** 22-23

- Roll Outs and Pull Outs 24-33
- Drawers 35-43
- Lazy Susans 44-49
- Pantries 50-55
- Lift Ups and Tip Ups 56-59
- Islands 60-63

- Organizers and Storage for the
 - Kitchen 64-71
 - Home Bar 72-73
 - Bathroom 74-77
 - Media Room & Family Room 78
 - Closet & Master Suite 79
 - Home Office & Hobby Room 80-81
 - Laundry Room & Mudroom 82-83

The kitchen shown on the front cover and inside front cover was created with the Xenon and Gillette door styles in Quarter Sawn Oak finished in Slate with Chocolate glaze. The island in this kitchen was created with the DeWitt door style in Lyptus finished in Java. The coffee station was created with the Xenon door style in Alder finished in Homestead Fog.

The traditional kitchen shown throughout this brochure was created with the Arlington door style in Cherry finished in Paprika with Chocolate glaze and Old World Distressing. The island in this kitchen was created with the Arlington door style in Maple finished in Macadamia with Chocolate glaze with Old World Distressing.

The kitchen shown on the back over and inside back cover was created with the Orian door style in Cherry finished in Hazelnut with Ebony glaze. The island in this kitchen was created with the Orian door style in Maple finished in Marshmallow Cream with Chocolate glaze.

*Get ready for the day,
the week, the month.*



Create a PLANNING ZONE



*Smoother days ahead
when there's a planning
zone in your home.*



1 Desk File Drawer Base Block 7295

2 Organizer Block 2300

3 Pull Out Keyboard Block 7285

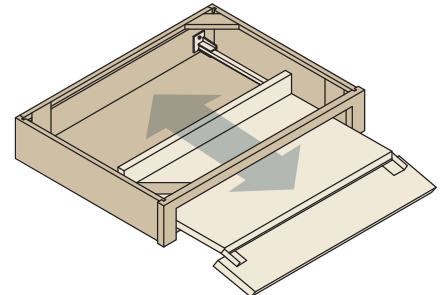
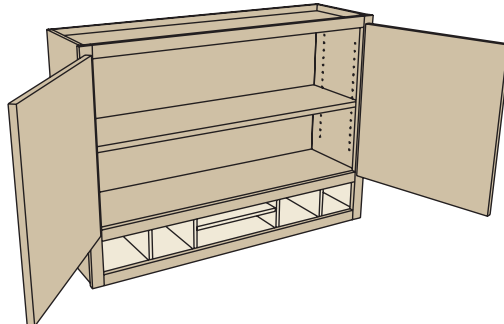
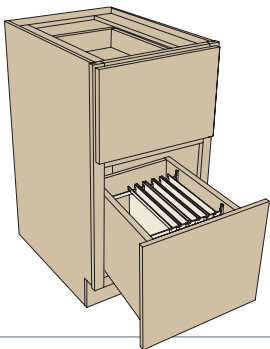

Create a PLANNING ZONE

TAKE NOTE

These features are built in, so the cabinet is ready to go.

- Key holder
- Message board
- Mail organizer

Install a power strip in the cabinet and use as a cell phone charger.



1 Wall Message Center Block 2299

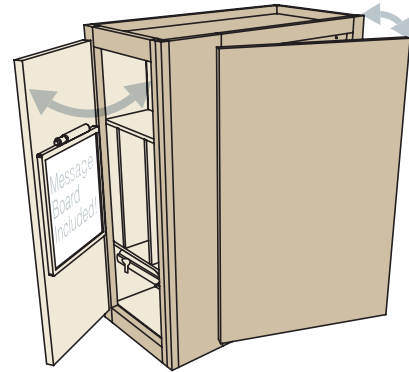

2 Open Shelf Wall Base with Beaded Back Block 4631

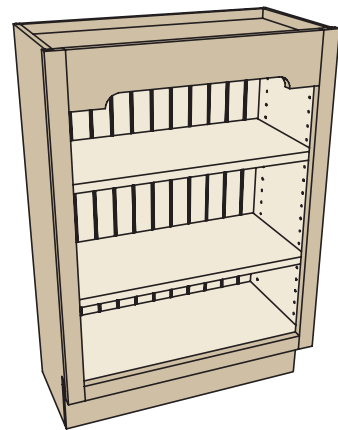

DRESS IT UP

Talk to your StarMark Cabinetry Dealer about valances, onlays, furniture feet and turned posts for your bookcase.

TAKE NOTE

Baskets, one per kid, in a bookcase are handy for school papers.



1 Cutlery Wood Rack Block 10250

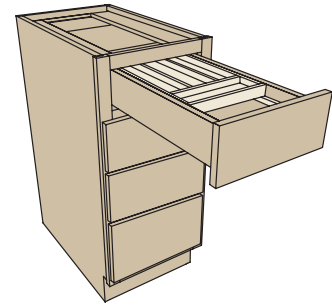

SMART DESIGN

The Cutlery Wood Rack is a divided box that rests on runners, creating two tiers, so there's more space in the same footprint.

2 All-Wood Drawer Organizer Block 10220

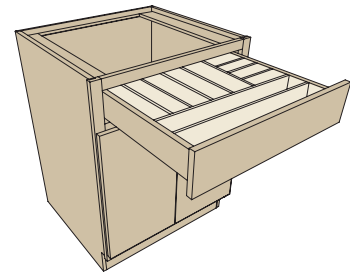

SMART DESIGN

Re-arrange the dividers to fit your stuff.

TAKE NOTE

A wide drawer can have multiple organizers to make the space exactly what you want.



3 Drawer Spice Rack
Block 10170

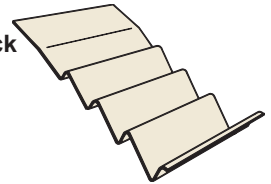

4 Pull Out Filler Storage Block 11110

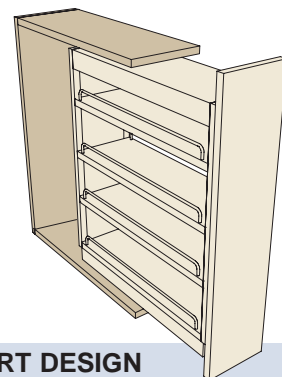

SMART DESIGN

All you need is a 3" wide space, and you gain 1.22 square feet of storage! If you have 6", you gain 2.96 square feet. And all of it comes rolling out to you.

Create a
SET THE TABLE ZONE

*Even napkin rings
and gravy boats
have a home.*



1 Drawer Organizer Block 10290

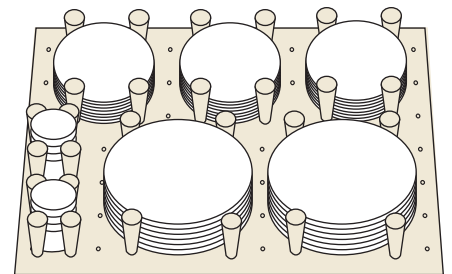
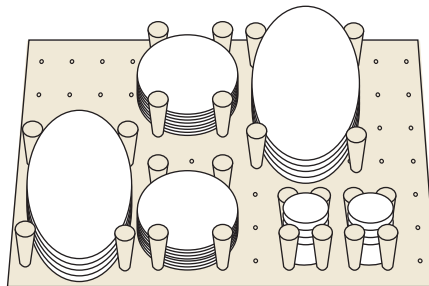
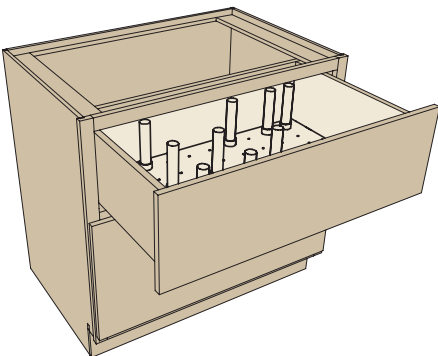

INFINITE ARRANGEMENTS!
Two possible arrangements are shown above.

Create a
SET THE TABLE ZONE



1 Knife Block
Block 10410

2 Base Pantry Block 3970 *Shown above with optional Knife Block.*

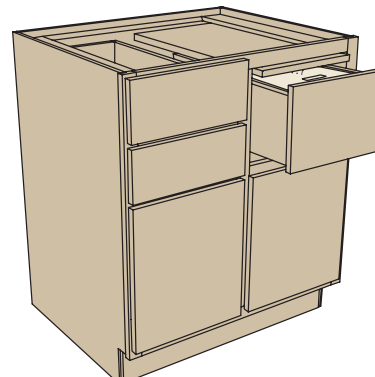
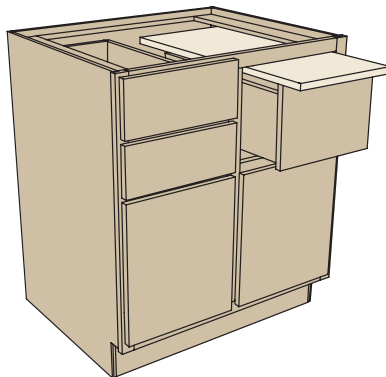
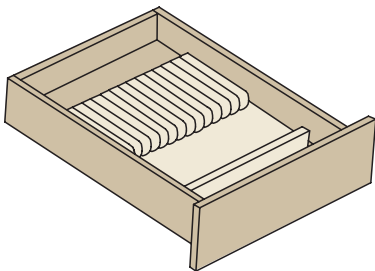

TAKE NOTE
Make the
Base Pantry's
two drawers
exactly right
for you when
you choose
from several
drawer inserts.

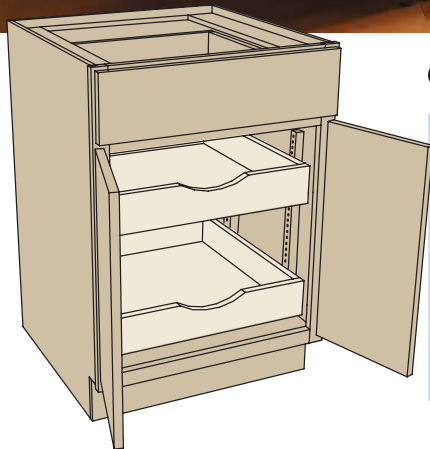

● **Base with Roll Out Trays** Block 4010

SMART DESIGN

Roll out trays adjust up and down to suit your contents.

Drawers and roll out trays glide all the way out for easy access to contents.

Soft close drawers and roll out trays ensure a smooth shut for dishes.

Create a SET THE TABLE ZONE

1 Drawer Base with Bread Board and Utensil Storage Block 3460

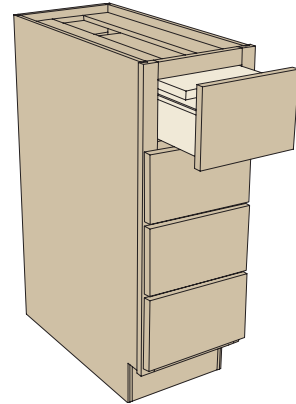

SMART DESIGN

Breadboard is concealed when drawer is shut.

2 Cutlery Wood Rack Block 10250

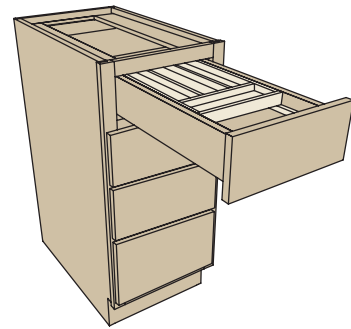

SMART DESIGN

The Cutlery Wood Rack is a divided box that rests on runners, creating two tiers, so there's more space in the same footprint.

3 Bread Liner Block 10280

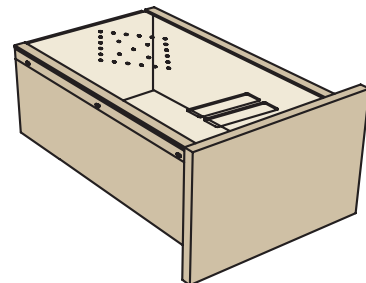

SMART DESIGN

Clear lid lets you know when you're running low.



1 Wall with Swing Out Pantry Block 1100

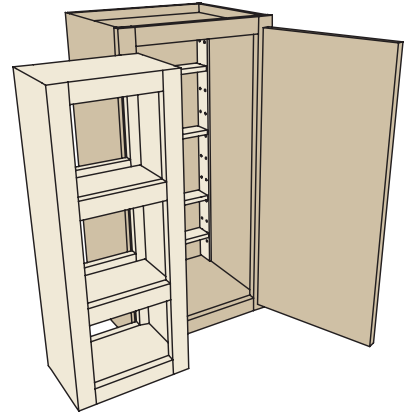

2 Spice Shelf Wall Block 1110

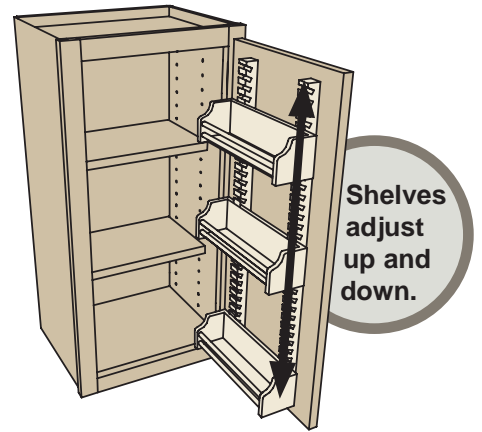

Shelves adjust up and down.

SMART DESIGN

Spice shelves adjust up and down to suit you.



3 Wall Pantry Block 1102

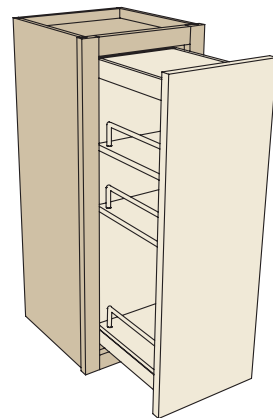

SMART DESIGN

A Wall Pantry keeps your cooking spray, oil, and seasonings close by, yet out of sight.

All shelves, except the bottom shelf, can be adjusted up and down.

Create a
MEAL PREP ZONE



*Keep it all at
your fingertips.*

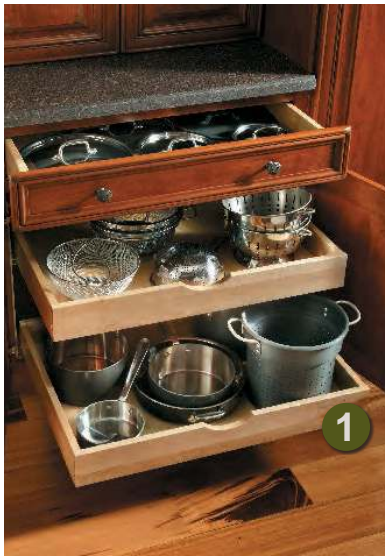

1 Base with Roll Out Trays
Block 4010

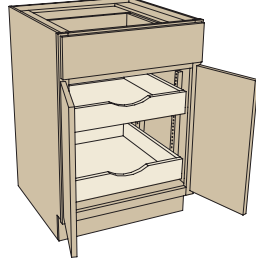

SMART DESIGN

Roll out trays adjust up and down to suit your contents.



5 Roll Out Tray Divider
Block 10490

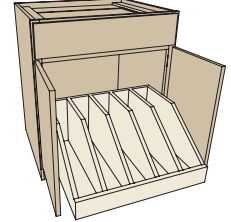

2 Base Pantry with Chrome/Wood Basket Shelves
Block 3995

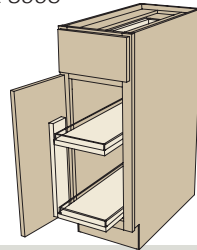

SMART DESIGN

Shelves adjust up and down to suit your contents.
Non-skid shelf surface.

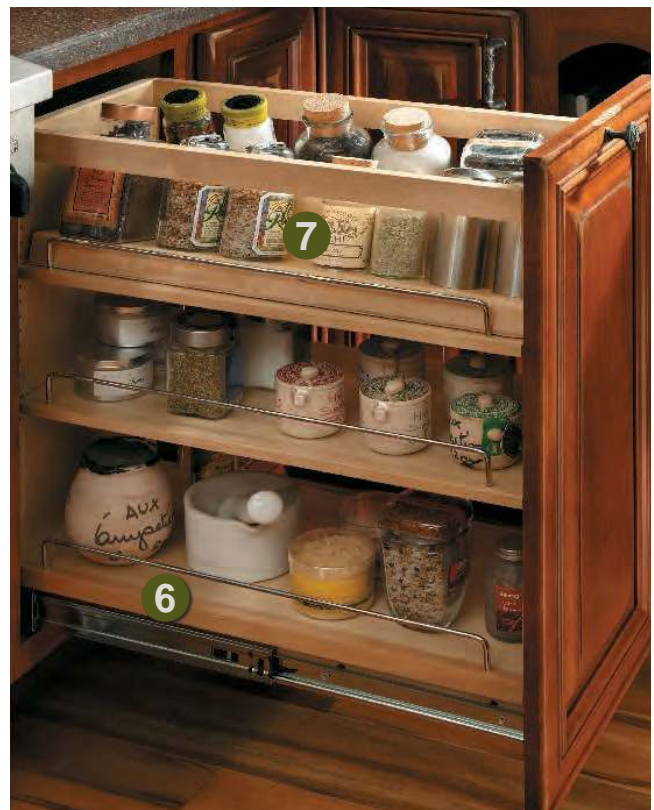

6 Base with Mini Pantry
Block 3990
Shown at above with optional Spice Rack.

7 Spice Rack for Base with Mini Pantry
Block 10150

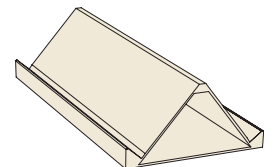
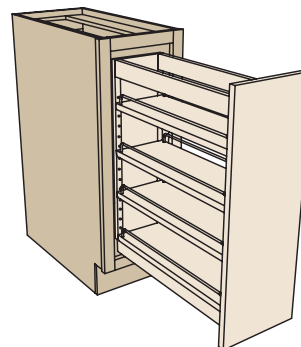

SMART DESIGN

In a space as small as 9" wide, you can add 2.44 square feet of storage. And all of it comes rolling out to you.



3 Tray Base with Drawer Above Block 3031

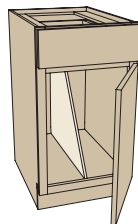

4 Base Mixer Shelf Block 4065

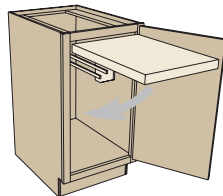

SMART DESIGN

When the shelf is lifted out of the opening, it locks in place. Release triggers under the shelf allow it to be lowered into the cabinet.

TAKE NOTE

Fits KitchenAid Professional Series mixers. Some mixers can be attached to the shelf.

Create a MEAL PREP ZONE



1 Base Pantry Block 3970
Shown at left with optional Wood Spice Rack Organizer.

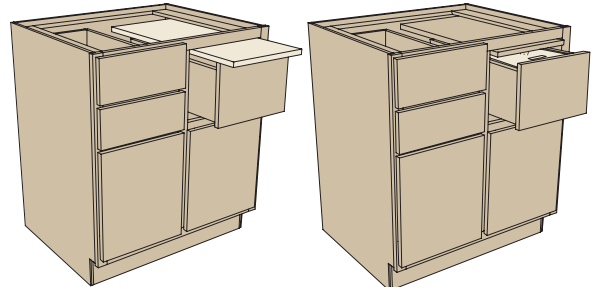

2 Wood Spice Rack Organizer
Block 10160

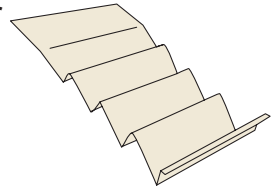

3 Pull Out Filler Storage
Block 11110

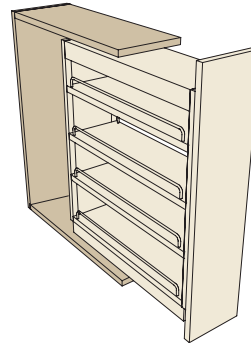

SMART DESIGN

All you need is a 3" wide space, and you gain 1.22 square feet of storage! If you have 6", you gain 2.96 square feet. And all of it comes rolling out to you.



4 Cutlery Tiered Rack Block 10200

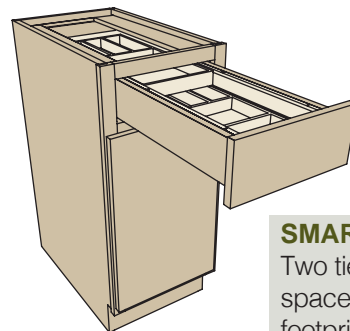

SMART DESIGN

Two tiers double the space in the same footprint.



Create a MEAL PREP ZONE

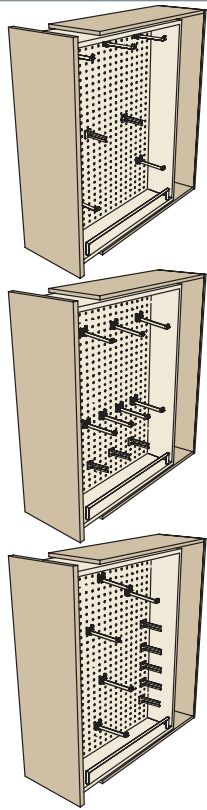

1 Pull Out Peg Storage Block 11120

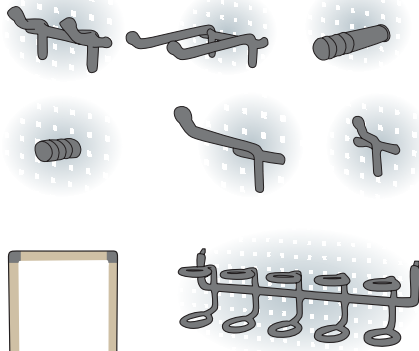

A Message Board for your Pull Out Peg cabinet is available to order separately. Measures 8 1/2" x 14 1/2" x 1/2".

INFINITE ARRANGEMENTS!

Three possible arrangements are shown at left.

SMART DESIGN

The style and number of hooks included will vary, depending on the cabinet ordered. All hooks are available to order separately and are illustrated above.



2 Base Pantry Block 3970

Shown at right with optional Knife Block.

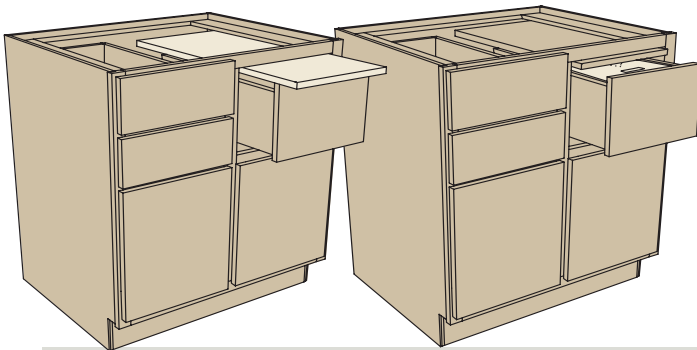

TAKE NOTE

Make the Base Pantry's two drawers exactly right for you when you choose from several drawer inserts.



3 Knife Block Block 10410

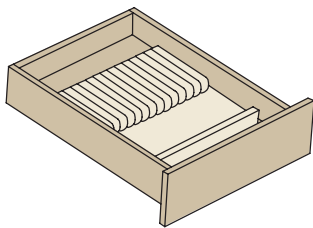

4 Chopping Block Block 10130

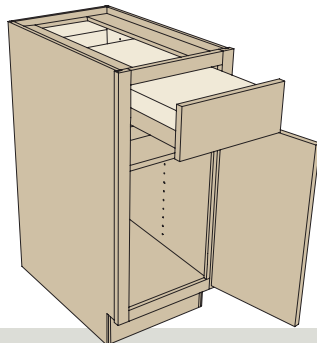

SMART DESIGN

Chopping block lifts out to reveal knives below. Block has rubber feet to stay put on your countertop.





1 Sink/Range Base with Spice Shelves
Block 3057

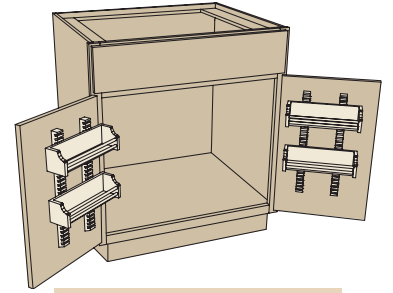

SMART DESIGN

Shelves adjust up and down to suit you.



2 Roll Out Tray (Floor Mount)
Block 10000

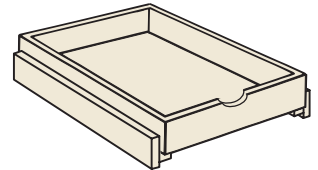

SMART DESIGN

Tray rolls out to you.



3 Folding Step
Block 10500

SMART DESIGN

A step up is always there when you need it.

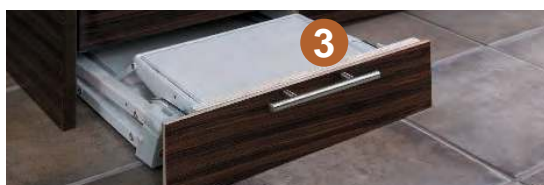

4 Base with Towel Bar
Block 3032

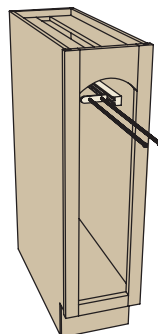

5 Sink/Range Base with Drawer Front Bin
Block 3053

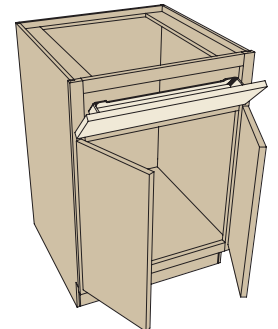

1 **Recycle Base**
Block 4130

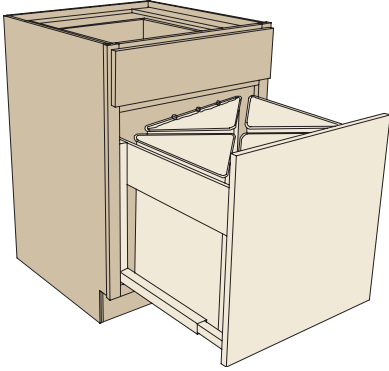

TAKE NOTE

Bins are removable so recyclables can go to the curb.



4 **Kitchen Waste Basket with Chopping Block** Block 4110

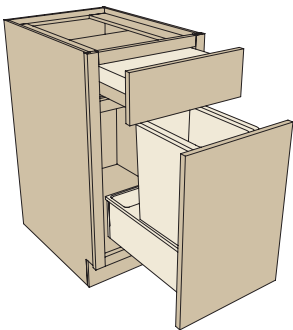

TAKE NOTE

Bins are removable so recyclables can go to the curb.

Create a
CLEAN UP ZONE



SMART DESIGN
Space for trash bags is built in.

2 **Kitchen Waste Basket** Block 4100

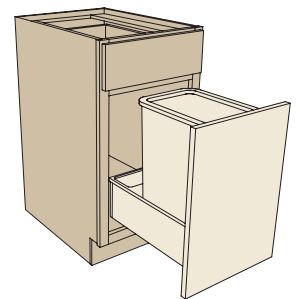

3 **Kitchen Waste Basket** Block 4100

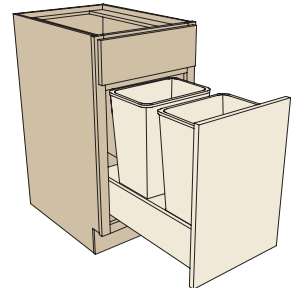

TAKE NOTE

Closes quietly.

1 Wall Spice Shelf
Block 10090

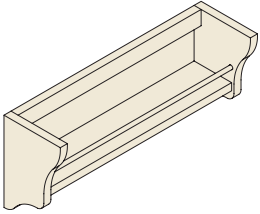

2 Base Island Unit
Style D Block 4429
Shown at right with optional beaded panel.

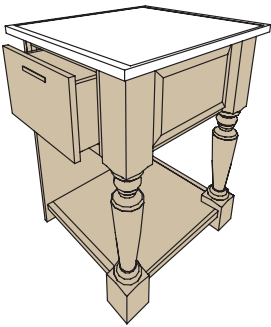

Create a DISPLAY ZONE

1 Plate Rack Block 2201

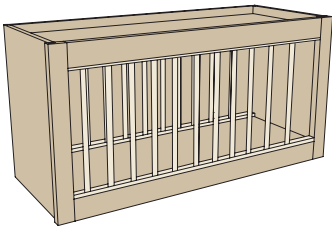

TAKE NOTE

Front ladder rack is removable for cleaning.

2 Stem Glass Rack Block 10120

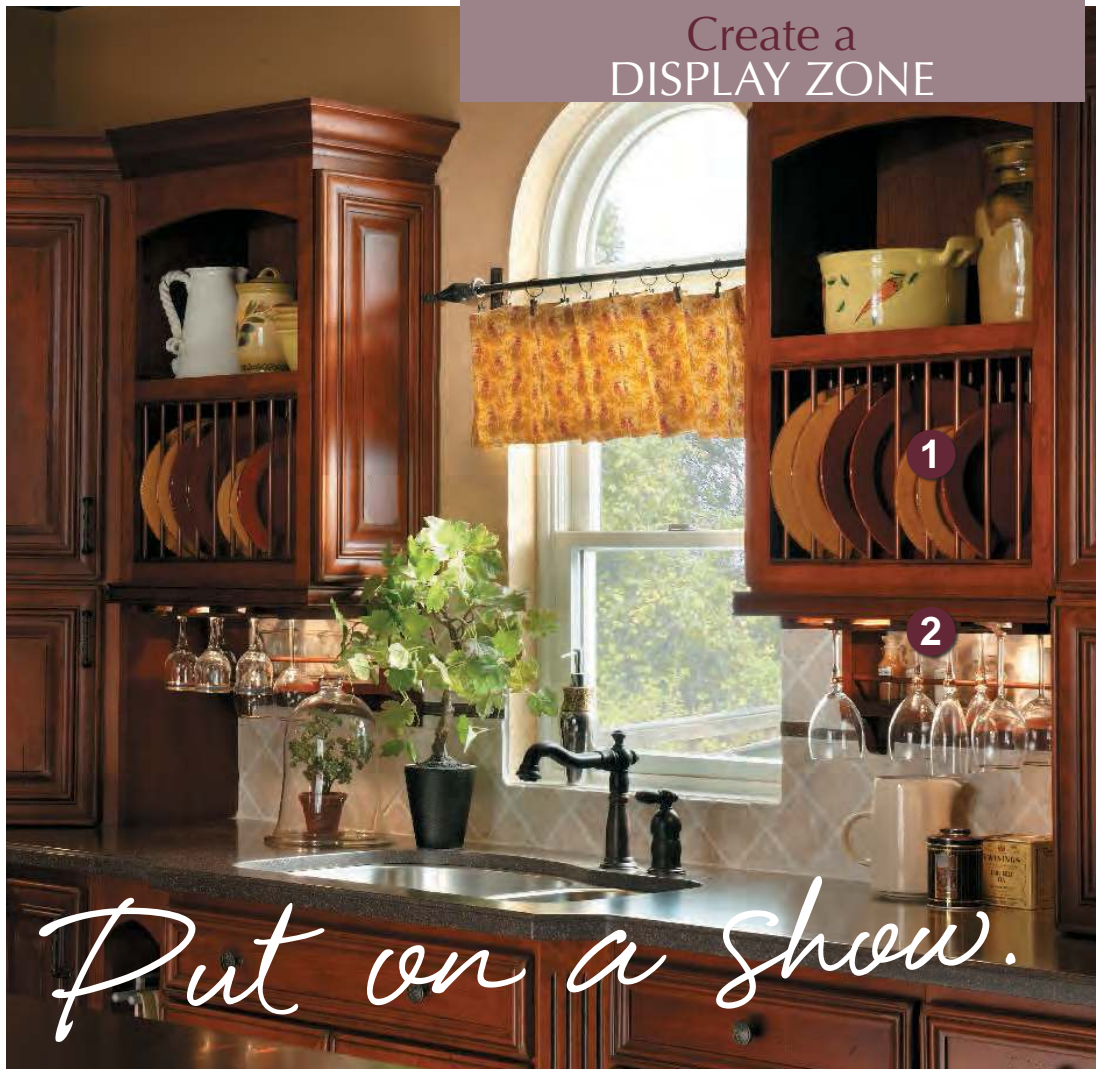
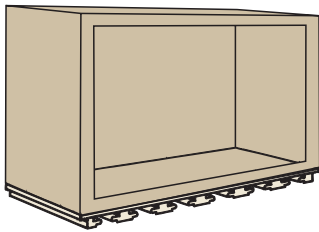

Put on a show.



3 Open Shelf Wall Base with Beaded Back Block 4631

DRESS IT UP

Talk to your StarMark Cabinetry Dealer about valances, onlays, furniture feet and turned posts for your bookcase.

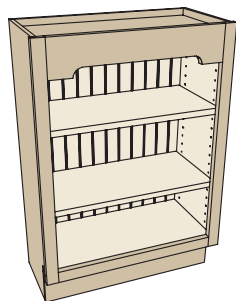

4 Vegetable Storage Drawer Block 9820

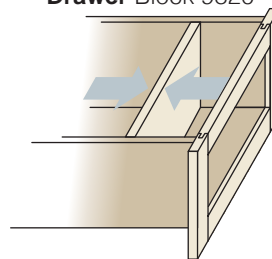

TAKE NOTE

The partition adjusts to hold your display. Pasta and beans are a popular style, but don't overlook your collections. Corks, vintage cookie cutters, rolling pins, toys, linens, matchbooks, tin recipe boxes, crate labels...there are many collections that add interest and texture to a room's design.



SMART DESIGN

Roll out trays adjust up and down to suit your contents.

Drawers and roll out trays glide all the way out for easy access to contents.

Soft close drawers and roll out trays ensure a smooth shut for dishes.



ROLL OUTS and
PULL OUTS

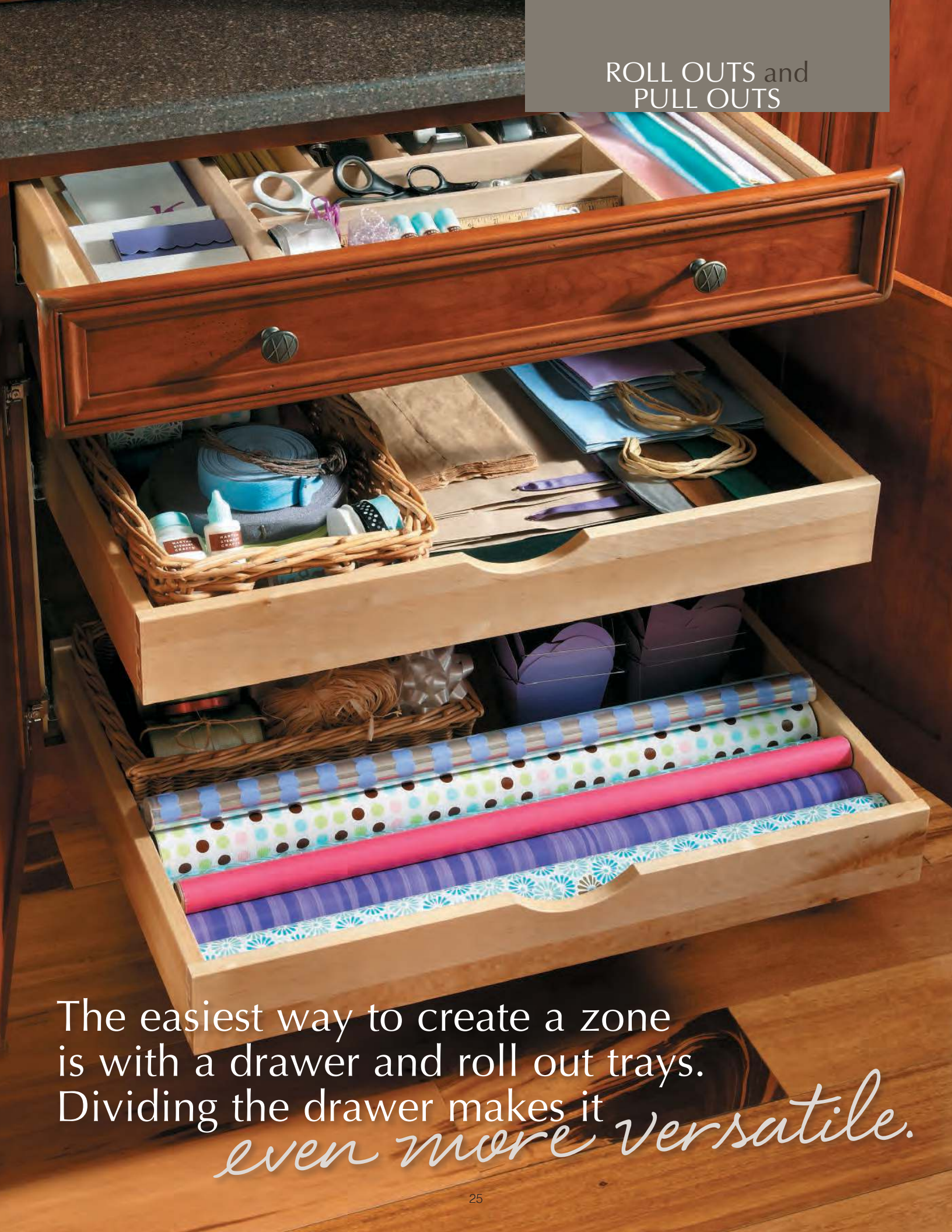

The easiest way to create a zone
is with a drawer and roll out trays.
Dividing the drawer makes it
even more versatile.

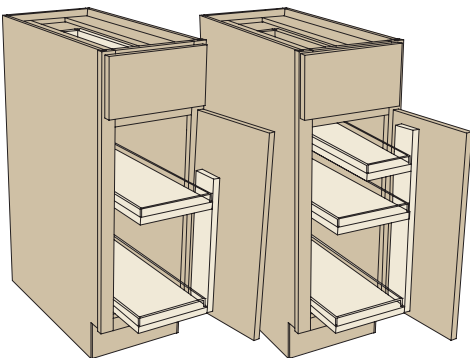

● **Base Pantry with Chrome/Wood Basket Shelves** Block 3995

SMART DESIGN

Shelves adjust up and down to suit your contents.

Non-skid shelf surfaces keep contents upright.

Two basket shelves included. Additional basket shelves can be ordered separately.



ROLL OUTS and PULL OUTS



1



2

1 Base Pantry with OXO Storage
Block 3997

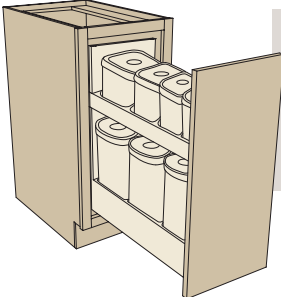

TAKE NOTE
Includes four small and three large OXO brand containers.

2 Base Plastic Ware Storage
Block 4067

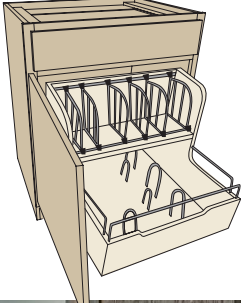

TAKE NOTE
Organization for plastic containers and coordinating lids.



3

3 Over Appliance Pull Out
Block 10323

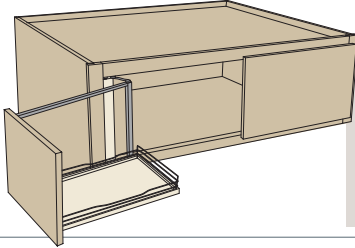

SMART DESIGN
Gain access to and visibility of hard to reach items above the refrigerator.



4

4 Utility Pull Out Pantry with Soft Close
Block 5185

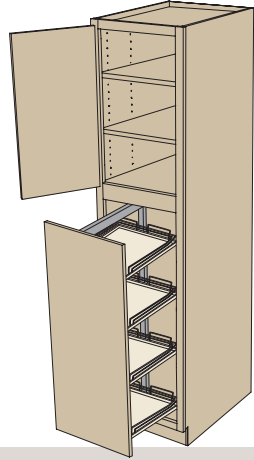

SMART DESIGN
Four adjustable chrome and wood shelves with non-skid surface.



● **Blind Corner* with
Revolving Slide Out Drawer Front**
Block 3162

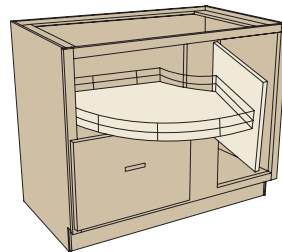

SMART DESIGN

Each drawer front shelf rolls out independently so you can access exactly what you need on both revolving side out shelves.

ROLL OUTS and PULL OUTS

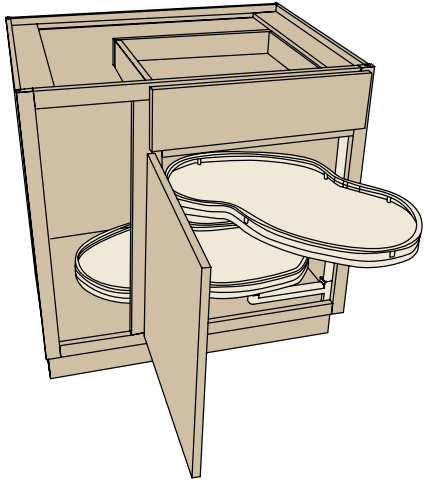

1 Blind Corner* with Swing Out Shelf
Block 3157



2 Blind Corner* with Magic Corner Shelves
Block 3159

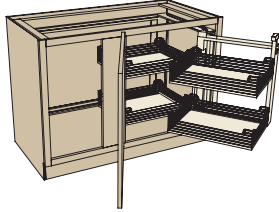

3 Blind Corner* Pantry with Chrome/Wood Basket Shelves
Block 3158

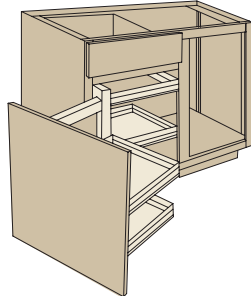

4 Blind Corner* with Roll Out Trays and Door Shelf
Block 3160

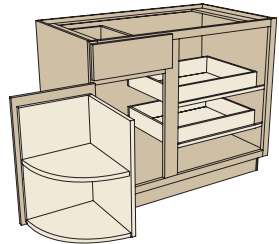

5 Blind Corner* with Revolving Shelf
Block 3155

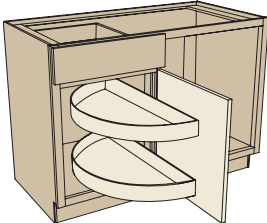

* Blind corners are explained on page 49.

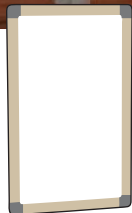

1 Pull Out Peg Storage
Block 11120

SMART DESIGN

The style and number of hooks included will vary, depending on the cabinet ordered. All hooks are available to order separately. They are illustrated on page 19.

A Message Board for your Pull Out Peg cabinet is available to order separately. Measures 8 5/8" x 14 1/8" x 1/2".

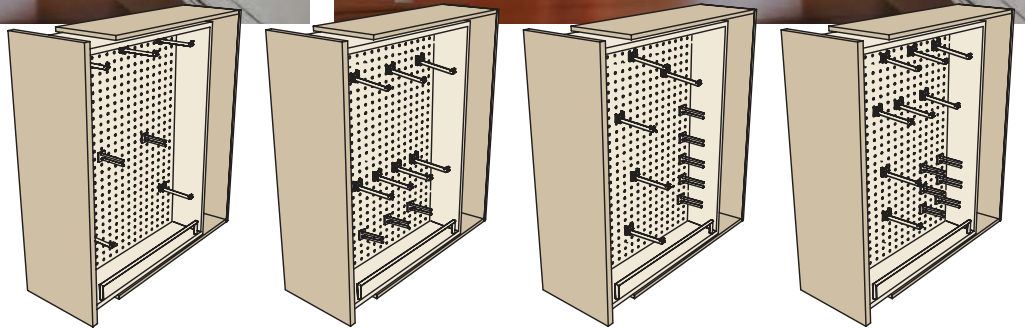

INFINITE ARRANGEMENTS!

Four possible arrangements are shown above.



2 Pull Out Filler Storage
Block 11110

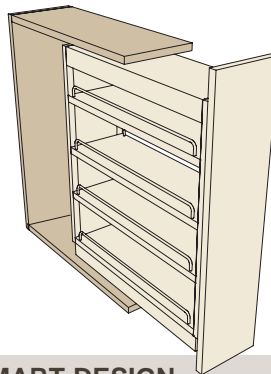

SMART DESIGN

All you need is a 3" wide space, and you gain 1.22 square feet of storage! If you have 6", you gain 2.96 square feet. And all of it comes rolling out to you.



3 Base with Wicker Basket Storage
Block 4095

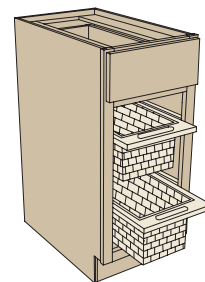

TAKE NOTE

Wicker baskets slide out and are decorative too.

ROLL OUTS and PULL OUTS



1 Vanity Organizer
Block 8085

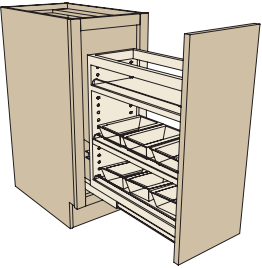

SMART DESIGN
Bins are removable for cleaning and mobility. In photo above, one bin is dedicated to first aid items, another to manicure tools, and another to hair styling tools.

2 Vanity Grooming Organizer
Block 8080

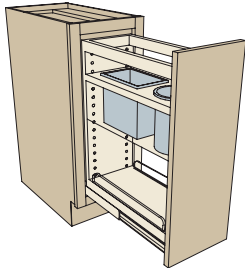

TAKE NOTE
Stainless steel bins hold hot irons and dryers without damage.



3 L Shaped Vanity Organizer
Block 10266

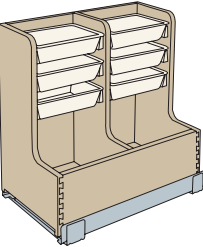

SMART DESIGN
The L shape allows room for plumbing and storage.



4 Two Drawer Base with Roll Out Tray
Block 3391

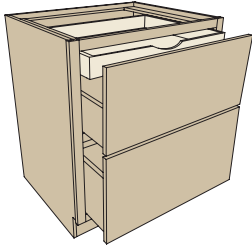

SMART DESIGN
Roll out tray is concealed when drawer is shut.



1 Base Full Height Door with Tall Roll Out Trays
Block 4000

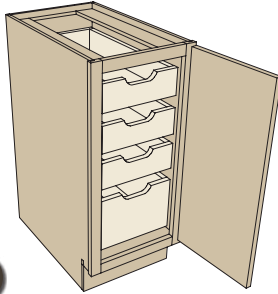

2 Base Pantry with Chrome/Wood Basket Shelves
Block 3995

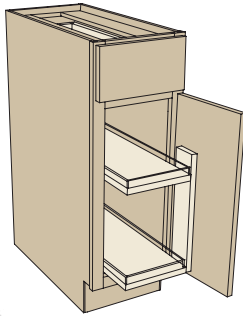

3 Range Base Reverse with Roll Out Trays
Block 4040

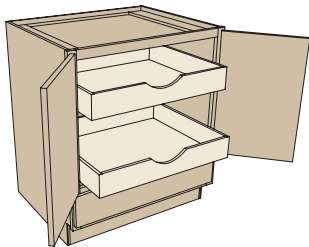

4 Range Mate
Block 4060

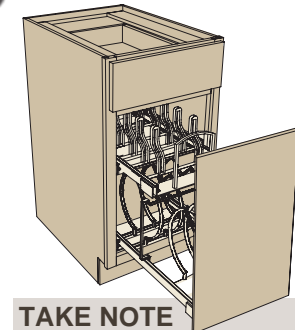

TAKE NOTE
Top rack holds up to seven lids. Adjust the bottom rack to hold pots and pans of many sizes.



5 Base with Pull Outs and Roll Outs
Block 3985

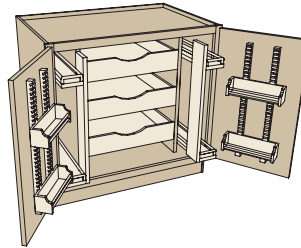

TAKE NOTE
Four Spice Shelves, three Roll Out Trays and four Basket Shelves are all adjustable.



6 Sink/Range Base with Drawer Front Bin
Block 3053

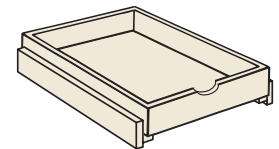
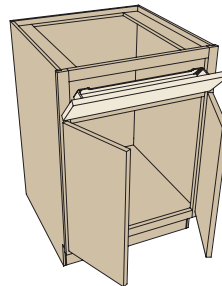

7 Roll Out Tray
Block 10000
(floor mount)

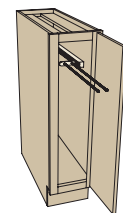

8 Sliding Towel Bar Kit
Block 10260

ROLL OUTS and PULL OUTS



1

1 Door Mount Aluminum Foil Rack Holder Block 10325

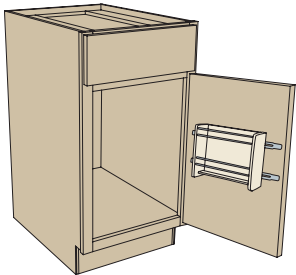

2

2 Base Pull Out Knife Block and Utensil Storage Block 3993

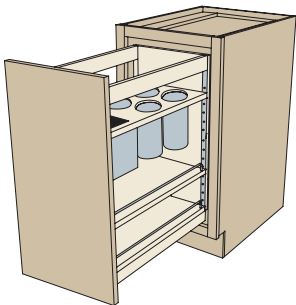

3

3 Utility with Roll Out Trays Block 5150

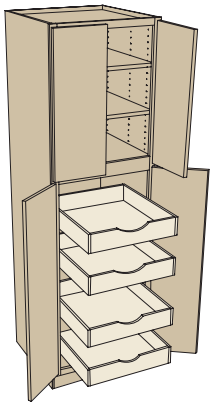

TAKE NOTE
Full depth shelves in upper portion and roll out trays in lower portion are all adjustable.

CONSTRUCTION

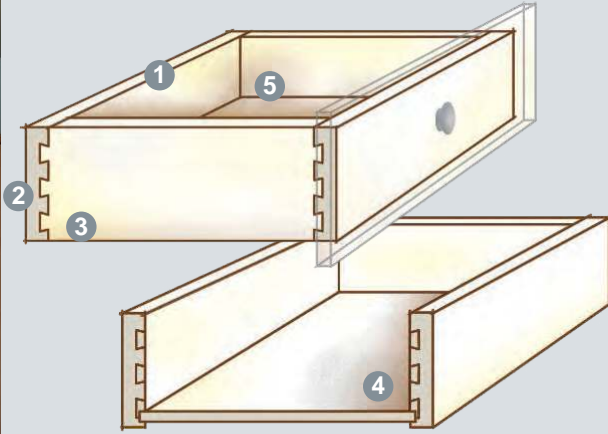

STARMARK CABINETRY DRAWERS

1. Constructed from 5/8" thick birch or optional walnut
2. Dovetail joinery insures a strong joint.
3. Glides extend fully so you can reach everything in the drawer. The glides are also soft close, so the drawer shuts itself the final two inches, quietly and peacefully. Glides are mounted underneath, so the drawer has a polished look when opened, and the glides don't collect dust.
4. Routes in the sides hold the bottom panel tight, so the drawer bottom is "captive," not just stapled or glued.
5. Rated at 100 pound capacity

STARMARK CABINETRY ROLL TRAYS

1. Constructed from 5/8" thick birch or optional walnut
2. Dovetail joinery insures a strong joint.
3. Glides extend fully so you can reach everything in the roll tray. The glides are also soft close, so the roll tray retracts itself the final two inches, quietly and peacefully. Glides are mounted underneath, so the tray has a polished look when opened, and the glides don't collect dust.
4. Routes in the sides hold the bottom panel tight, so the tray bottom is "captive," not just stapled or glued.
5. Rated at 100 pound capacity

SOFT CLOSE DRAWERS & DOORS: PEACE IN THE KITCHEN.

Imagine this in your home: cabinet drawers that extend fully and close quietly, and cabinet doors that close quietly. StarMark Cabinetry drawers are standard with full extension for easy access, no glide hardware showing, and a whisper quiet close that steers even fully loaded drawers to a smooth, silent closure. Soft close doors are standard on all overlay cabinetry, and on inset cabinetry built with concealed hinges.



Ask your StarMark Cabinetry dealer about optional Walnut drawer boxes and roll out trays.



DRAWERS



1 Cutlery Divider Box
Block 10230

2 Wood Spice Rack Organizer
Block 10160

TAKE NOTE

Two cutlery divider boxes and a spice insert make the most of this wide drawer.

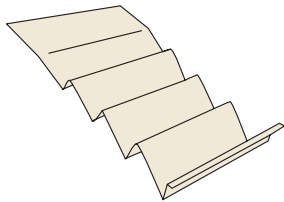
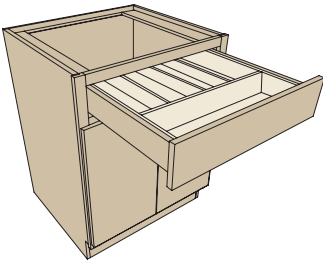

All the organizers shown in the Drawers section are “drop in’s,” except for the Cutlery Tiered Rack shown on page 39.



1 Cutlery Expandable Rack Block 10210

2 All Wood Drawer Organizer Block 10220

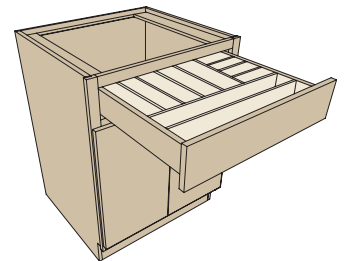
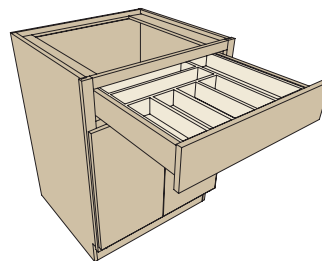

SMART DESIGN
Re-arrange the dividers to fit your stuff.



DRAWERS

1 Base Pantry
Block 3970
Shown at right with optional Knife Block.

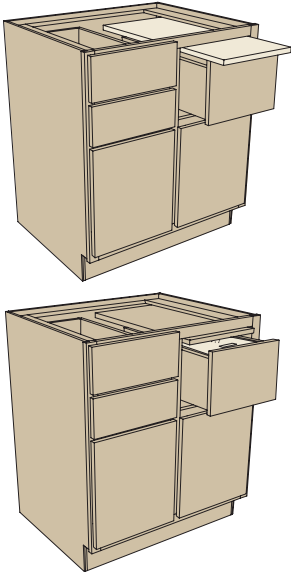

TAKE NOTE
Make the Base Pantry's two drawers exactly right for you when you choose from several drawer inserts.



2 Knife Block
Block 10410

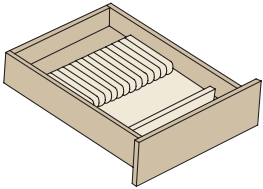

3 Chopping Block
Block 10130

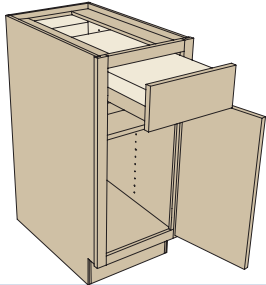

TAKE NOTE
Chopping block lifts out to reveal knives below. Block has rubber feet to stay put on your countertop.

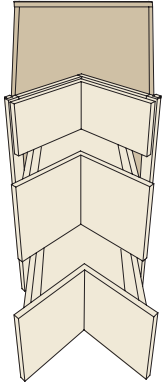

● **Square Corner Drawer Base**
Block 3337



DRAWERS



1 Cutlery Tiered Rack
Block 10200

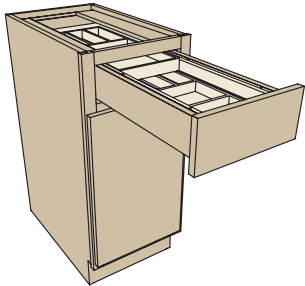

SMART DESIGN
Two tiers double the space in the same footprint.



2 Beverage Pod Tiered Rack
Block 10202

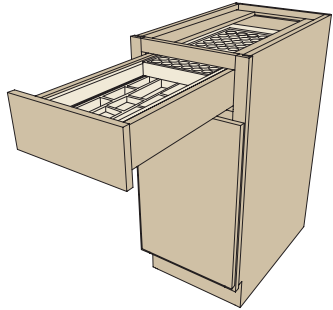

SMART DESIGN
Two tiers double the space in the same footprint.



Tailor drawers to your hobbies.

Spice racks and cutlery dividers work well all through the house.

TAKE NOTE

A wide drawer can have multiple organizers to make the space exactly what you want.

- 1 **Cutlery Wood Rack**
Block 10250

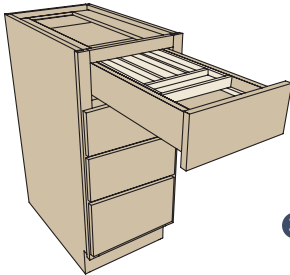

- 2 **Drawer Spice Rack**
Block 10170

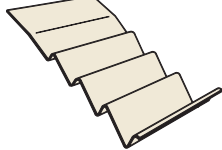

- 3 **All-Wood Drawer Organizer**
Block 10220

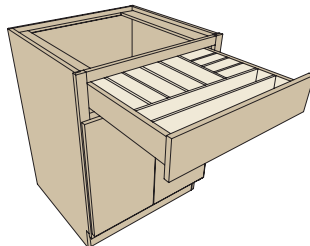

SMART DESIGN

The Cutlery Wood Rack is a divided box that rests on runners, creating two tiers so there's more space in the same footprint.

SMART DESIGN

Re-arrange the dividers to fit your stuff.



DRAWERS



1 Drawer Spice Rack
Block 10170



2 Cutlery Divider
Block 10240

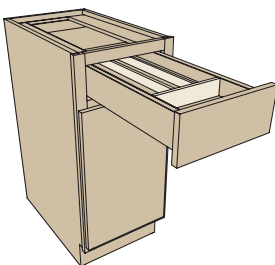

3 All-Wood Drawer Organizer
Block 10220

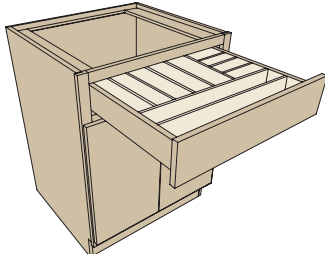

SMART DESIGN
Re-arrange the dividers to fit your stuff.



- 1 **Drawer Organizer**
Block 10290
- 2 **Drawer Peg Pan Storage**
Block 10291
- 3 **Drawer Peg Lid Storage**
Block 10291

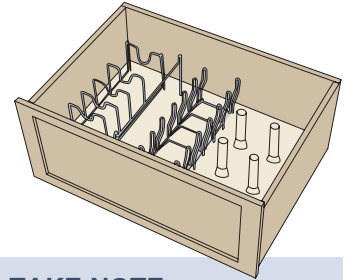

TAKE NOTE

Please order the Drawer Organizer when you order the Drawer Peg Pan Storage or the Drawer Peg Lid Storage so you have the necessary insert. The insert covers the bottom of the drawer and contains a grid of holes that the Drawer Peg Pan Storage and the Drawer Peg Lid Storage rest in.



- 4 **Fineline Cutlery Inserts**
Block 10221
- 5 **Fineline Cutlery Box**
Block 10222
- 6 **Fineline Cutlery Box Deep**
Block 10223

SMART DESIGN

Mix and match the inserts shown here to create customized drawer storage.

TAKE NOTE

Available in Birch or Walnut.



DRAWERS



1 Cutlery Expandable Rack
Block 10210

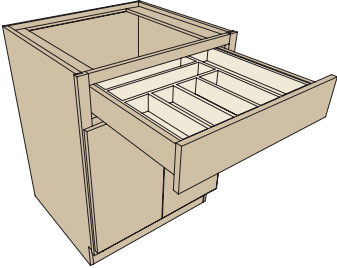

3 Plastic Cutlery Divider
Block 10190

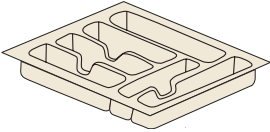

TAKE NOTE
Easy to clean.



2 Tiered Vanity Drawer Organizer
Block 10205

New!

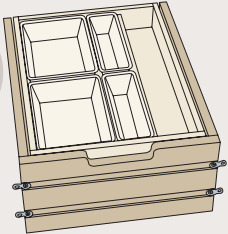

SMART DESIGN
Two tiers double the space in the same footprint.



4 Half Tiered Vanity Drawer Organizer
Block 10206

New!

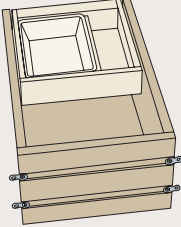

SMART DESIGN
Non-slip liners hold contents in place.



1 Diagonal Wall Lazy Susan with Door Blocks 1516 and 10300

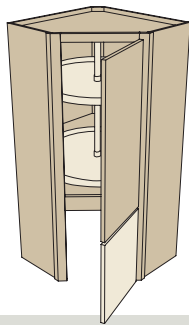

TAKE NOTE

In the lower portion, the door option gives you the most height for countertop appliances.



2 Diagonal Wall with Wood Turntables and Drawers Block 1534

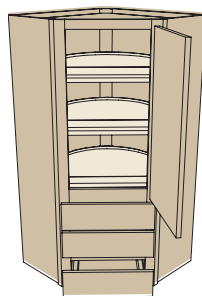

TAKE NOTE

Contains three turntables, not just two, and the top two are adjustable.



3 Diagonal Wall Lazy Susan with Tambour Block 1530

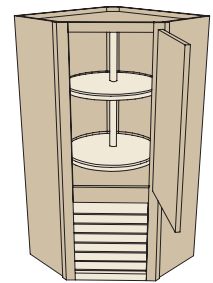

TAKE NOTE

Adjust the turntables to a height you like.



4 Diagonal Wall with Chrome/Wood Lazy Susan Block 1525

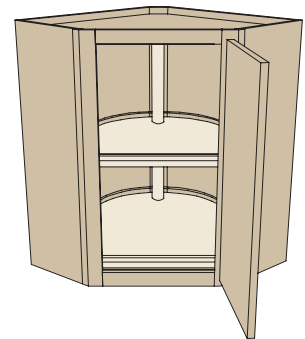

SMART DESIGN

Pole is in back, not center, to give you the most shelf space. Non-skid shelf surface means no more crashes.

LAZY SUSANS





1 Square Base Corner with Revolving Slide Shelf
Block 3335

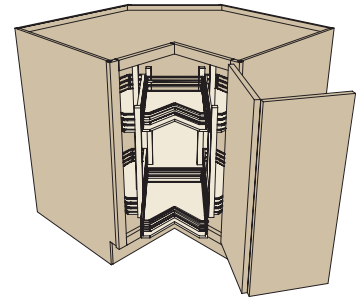

SMART DESIGN

Shelf baskets pull out and unit rotates 90° each direction so you can reach the side shelves.



2 Square Super Susan with Chrome/Wood Turntables
Block 3323

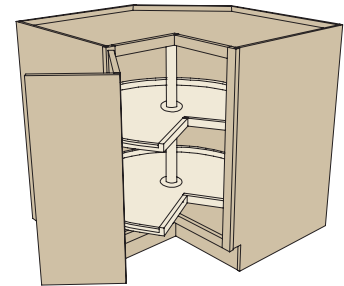

TAKE NOTE

Non-skid shelf surface means no more crashes.



3 Square Super Susan
Block 3310

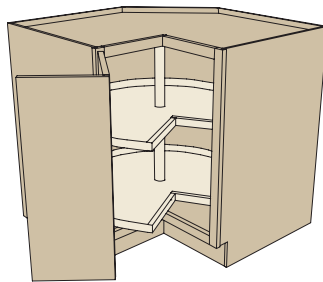

4 Square Super Susan with Wood Turntables
Block 3320

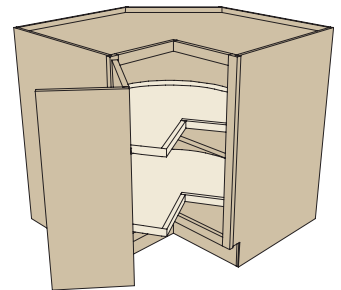

LAZY SUSANS

Access is easy with two doors.



1 Diagonal Lazy Susan with Chrome/Wood Turntables
Block 3347

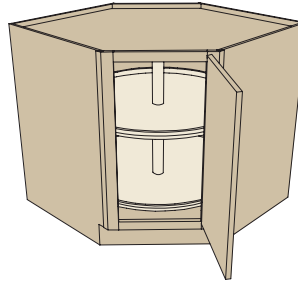

TAKE NOTE

On an exterior corner, cabinets with a lazy susan inside can blend in when a functional door or decorative panel is applied to the exterior.

TAKE NOTE

Non-skid shelf surface means no more crashes.

2 Diagonal Corner Lazy Susan with Wood Turntables
Block 3346

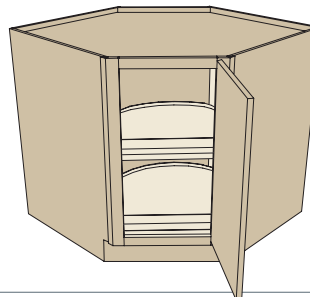



1 Blind Corner with Magic Corner Shelves
Block 3159

SMART DESIGN

Pull the front baskets out to you, and the rear baskets come to the front.

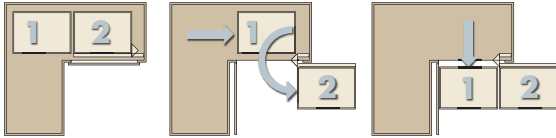
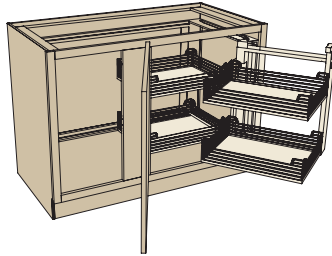

2 Blind Corner with Roll Out Trays and Door Shelf
Block 3160

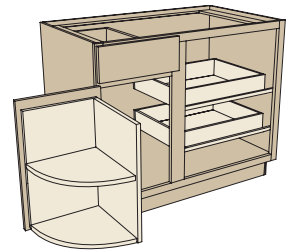

3 Blind Corner Pantry with Chrome/Wood Basket Shelves
Block 3158

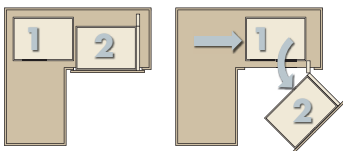
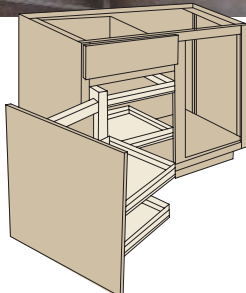

4 Blind Corner with Revolving Shelves
Block 3155

SMART DESIGN

Shelves rotate then slide forward.

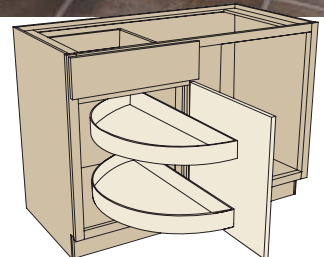

LAZY SUSANS

Corners are usable again!

Choose from many options that bring the goodies to you.



You can't see well into blind corner cabinets, so they are named well! Blind corners are dead space in a room. They hold the punch bowl and turkey roaster used once or twice a year—it's just too hard to fetch stuff from a "blind corner."

Don't settle for blind corners. We have several options that transform corners into easy to reach storage areas.

Lazy susans spring to mind when people think of making a corner useful. When there isn't room for a lazy susan—they require 33 or 36 inches both ways from the corner—consider the options on these two pages.

Accessories for blind corner cabinets are configured so shelves and their contents come to you.

● **Blind Corner with Swing Out Shelf** Block 3157

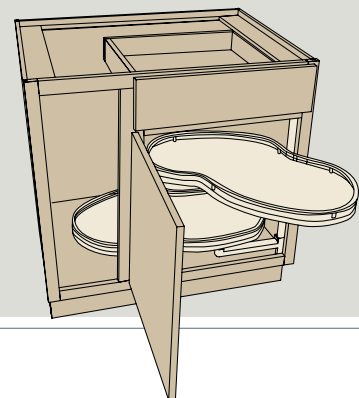



1 Utility Canned Goods Storage Block 5180

*Shown above in 96" height,
shown below in 84" height.*

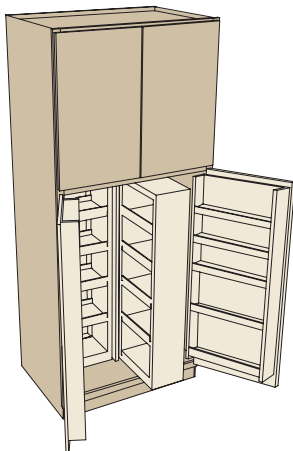

2 Utility with Roll Out Trays Block 5150

*Shown above in 96" height,
shown below in 84" height.*

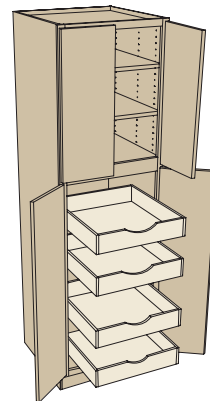

PANTRIES





1

1 Super Chef's Pantry Block 5120

*Shown above in 96" height,
shown below in 84" height.*

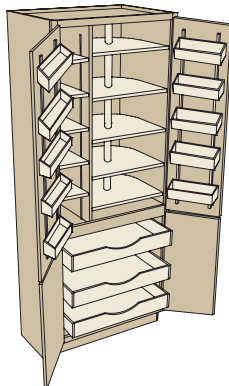

SMART DESIGN

Five adjustable turntables, four adjustable door mount shelves.



2

2 Super Chef's Pantry with Drawers Block 5130

*Shown above in 96" height,
shown below in 84" height.*

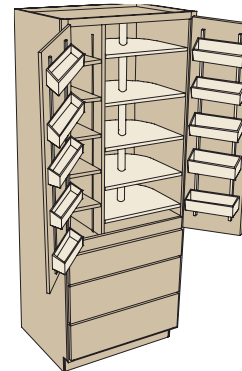

SMART DESIGN

Five adjustable turntables, four adjustable door mount shelves.

PANTRIES



Roll out trays make it easy to create zones.



Dedicate each roll out tray to one purpose. Above, the first roll out tray holds baking ingredients. The third roll out tray holds ingredients for from-scratch meals. The second and fourth bottom roll out tray holds snacks the kids can reach.

1 Utility Broom and Roll Tray Combination Block 5032

Shown above with optional Face Frame and Door on cabinet side. This option creates a functional side door.

Shown above in 96" height, shown at right in 84" height.

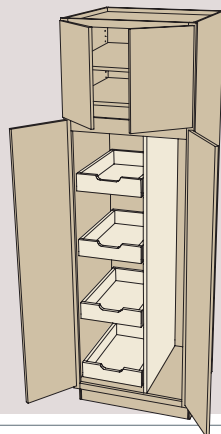

2 Utility Pull Out Pantry Block 5190

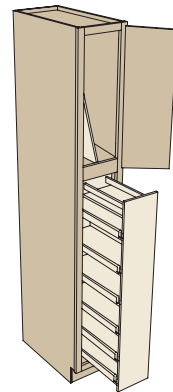

TAKE NOTE

Tray divider in upper portion organizes your platters, trays, baking sheets, pizza peels and baking stones.



1 Wall Pantry
Block 1102

Shown at left in 36" high, providing a bonus shelf at top.

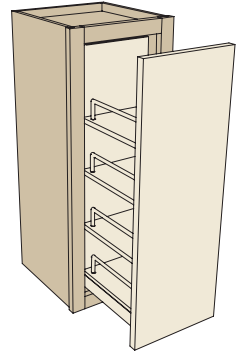

SMART DESIGN
All shelves, except the bottom shelf, can be adjusted up and down.



2 Wall with Swing Out Pantry
Block 1100

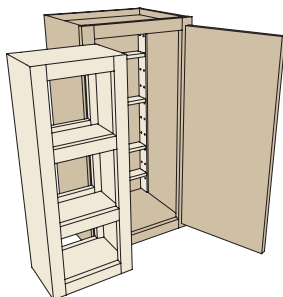

3 Wall Pantry
Block 1102

SMART DESIGN
All shelves, except the bottom shelf, can be adjusted up and down.

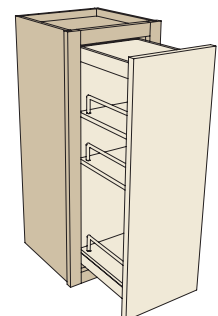

PANTRIES



1 Base Canned Goods Storage
Block 3980

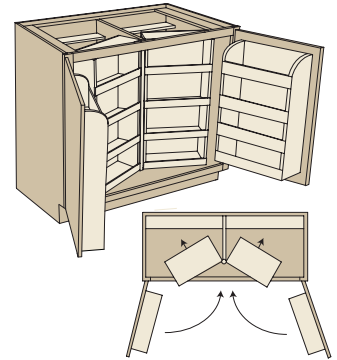

2 Base with Pull Outs and Roll Outs
Block 3985

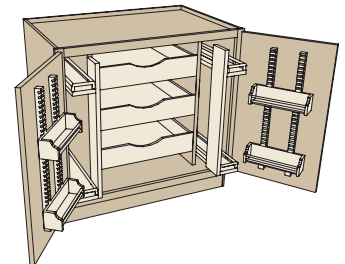

TAKE NOTE
Four Spice Shelves, three Roll Out Trays and four Basket Shelves are all adjustable.



1 Wall with Appliance Door Vertical Lift Up Block 2002

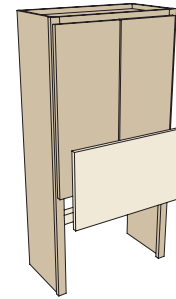

TAKE NOTE

The ultimate appliance hideaway. Features soft close, and about an inch more clearance than a tambour.



2 Wall Cabinet with Bifold Door Block 1120

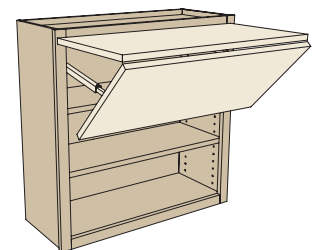

TAKE NOTE

Bifold doors have soft close.



● Wall Cabinet with Tip Up Door
Block 1115

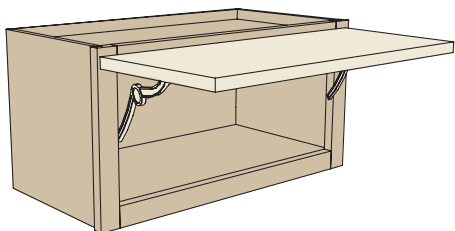



1 Wall with Appliance Door Vertical Lift Up Block 2002

TAKE NOTE

This is the ultimate appliance hideaway. Features soft close, and about an inch more clearance than a tambour.

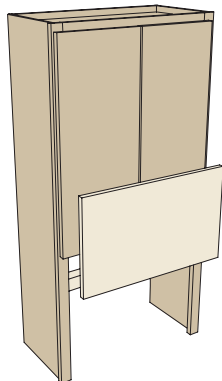

2 Wall with Appliance Door Block 2001

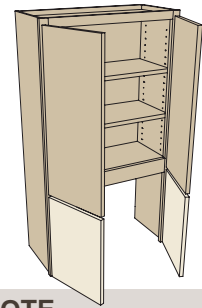

TAKE NOTE

In the lower portion, the door option gives you the most height for countertop appliances.



3 Wall with Tambour Door Block 2000

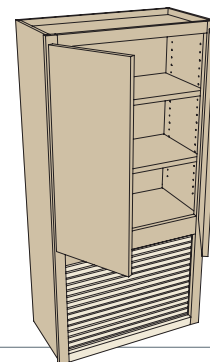

LIFT UPS and TIP UPS



1 Side Mount Pocket Door Block 9700

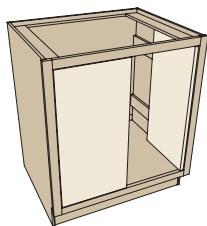

2 Top Mount Pocket Door Block 9700

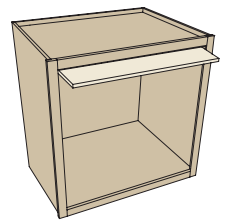



ISLANDS





TAKE NOTE

You can choose an island countertop to match the main kitchen or specify an accent color.

1 Base Island Unit -Style C
Block 4428

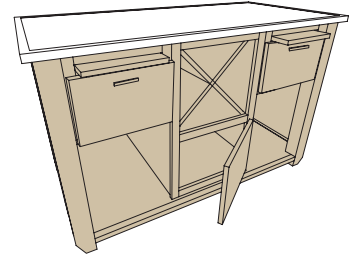

2 Base Island Unit -Style A
Block 4426

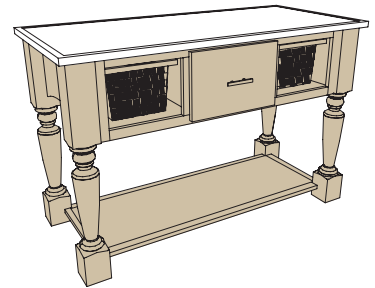

3 Base Island Unit -Style D
Block 4429

Shown on previous page with optional beaded panel.

Shown at left installed next to an 18" wide base cabinet.

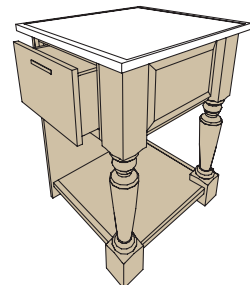

ISLANDS



1 Base Island Unit - Style B
Block 4427

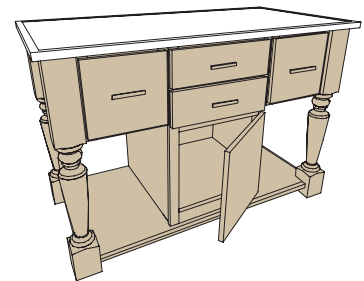

2 Base Island Unit
Block 4425

Shown at left with optional onlays.

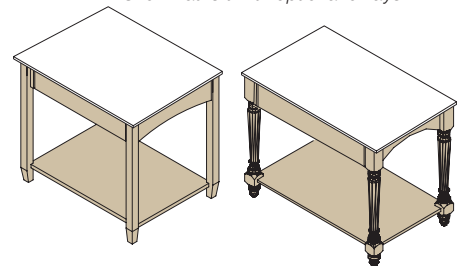

Countertops are not included. Wood tops and butcher block tops are available from StarMark Cabinetry. Ask your StarMark Cabinetry dealer for details.

KITCHEN ORGANIZERS and STORAGE

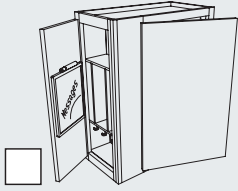

Wall Message Center
Block 2299 Works well in
mudrooms too.



Refrigerator Wall with
Tip Up Door **Block 1081**

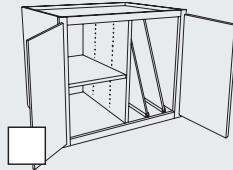

Refrigerator Wall with
Tray Dividers **Block 1085**

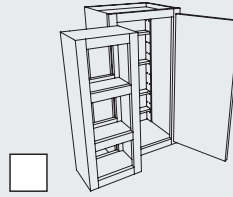

Wall with Swing Out
Pantry **Block 1100**
Works well in bathrooms and
hobby rooms too.

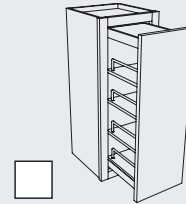

Wall Pantry **Block 1102**
Works well in bathrooms and
hobby rooms too. All shelves,
except the bottom shelf, can
be adjusted up and down.

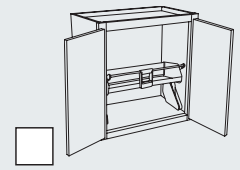

Wall Pull Down Pantry
Single Shelf **Block 1105**
Double Shelf **Block 1106**

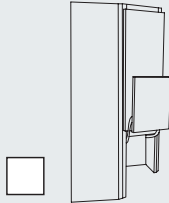

Diagonal Wall with
Lift Up Door
Block 1506
Deep **Block 1507**

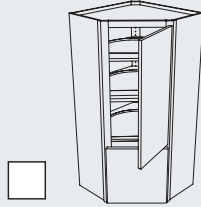

Diagonal Wall with
Wood Trays and
Lift Up Door **Block 1508**

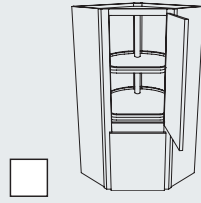

Diagonal Wall with
Chrome/Wood Lazy
Susan and Lift Up Door
Block 1509

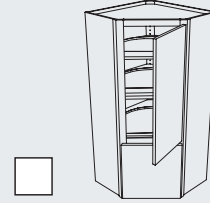

Deep Diagonal Wall with
Wood Trays and
Lift Up Door **Block 1510**

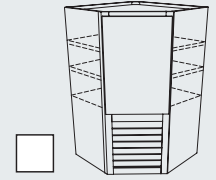

Diagonal Wall with
Tambour **Block 1511**
Works well in bathrooms
and hobby rooms too,
to store small appliances.

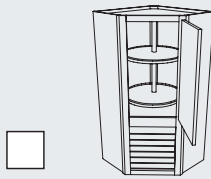

Diagonal Wall Lazy
Susan with Tambour
Block 1530
Works well in bathrooms
and hobby rooms too,
to store small appliances.

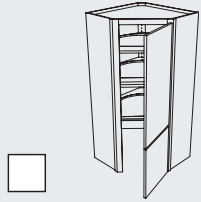

Diagonal Wall with
Wood Trays and Door
Block 1531
Works well in bathrooms
and hobby rooms too,
to store small appliances.

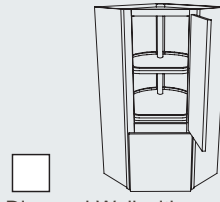

Diagonal Wall with
Chrome/Wood Lazy
Susan and Door
Block 1532
Works well in bathrooms
and hobby rooms too,
to store small appliances.

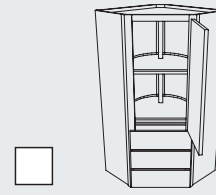

Diagonal Wall with
Chrome/Wood Lazy
Susan and Drawers
Block 1533

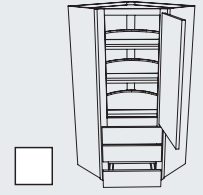

Diagonal Wall with
Wood Turntables
and Drawers **Block 1534**

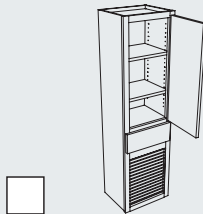

Wall with Tambour and
Drawer **Block 2010**
Works well in bathrooms and
hobby rooms too, to store
small appliances.

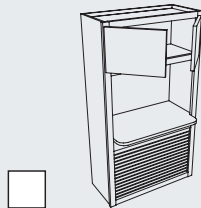

Microwave Wall with
Tambour **Block 2060**
Works well for holding TV's
in the kitchens too.

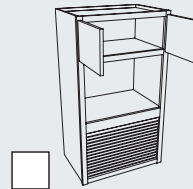

Microwave Garage with
Tambour **Block 2070**
Works well for holding TV's
in the kitchens too.

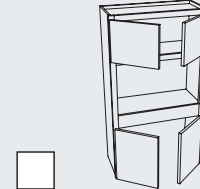

Microwave Garage with
Appliance Doors
Block 2071
Works well for holding TV's in
the kitchens too.

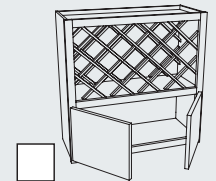

Criss Cross Wine Rack
above Doors **Block 2098**

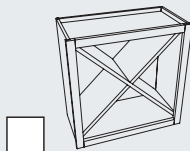

Wall Wine Diagonal
Block 2104
Works well in bathrooms
too, to organize towels, and
in hobby rooms, to organize
yarn and fabric.

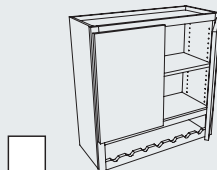

Wall with Wine Rack
Bottom **Block 2110**

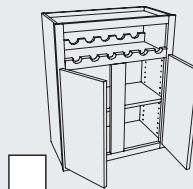

Wall with Wine Rack Top
Block 2120

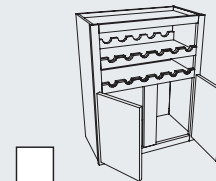

Wall with Double Wine
Rack Top **Block 2130**

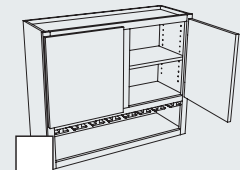

Wall with Stem Glass
Rack **Block 2140**

KITCHEN ORGANIZERS and STORAGE

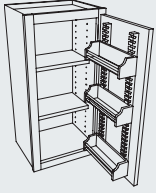

Spice Shelf Wall
Block 1110
Works well in bathrooms and hobby rooms too.



Wall Cabinet with
Tip Up Door **Block 1115**



Wall Stacked Tower A
Block 1158
Towers are also useful for creating custom hearth hoods.

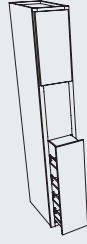

Wall Stacked Tower B
Block 1159
Towers are also useful for creating custom hearth hoods.

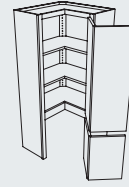

Square Corner Wall with
Appliance Door
Block 1415
Works well in bathrooms and hobby rooms too, to store small appliances.

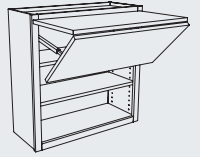

Wall Cabinet with
Bifold Door **Block 1120**

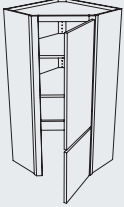

Diagonal Wall with Door
Block 1516

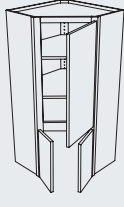

Deep Diagonal Wall with
Butt Doors **Block 1518**

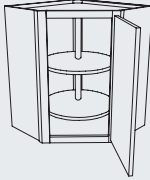

Diagonal Wall with
Lazy Susan **Block 1520**

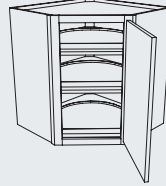

Diagonal Wall with
Wood Trays **Block 1522**

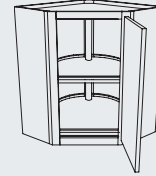

Diagonal Wall with
Chrome/Wood Lazy
Susan **Block 1525**

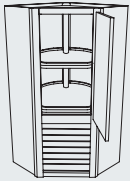

Diagonal Wall with
Chrome/Wood Lazy
Susan with Tambour
Block 1535
Works well in bathrooms and hobby rooms too, to store small appliances.

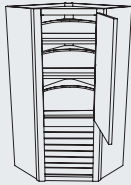

Diagonal Wall with
Wood Turntables
and Tambour **Block 1536**
Works well in bathrooms and hobby rooms too, to store small appliances.

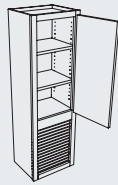

Wall with Tambour
Block 2000
Works well in bathrooms and hobby rooms too, to store small appliances.

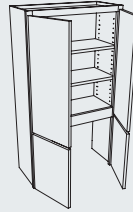

Wall with Appliance Door
Block 2001
Works well in bathrooms and hobby rooms too, to store small appliances.

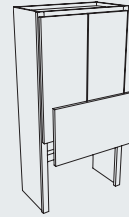

Wall with Appliance Door
Vertical Lift Up
Block 2002
Works well in bathrooms and hobby rooms too, to store small appliances.

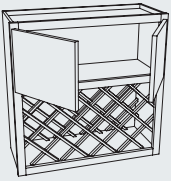

Criss Cross Wine Rack
below Doors **Block 2099**

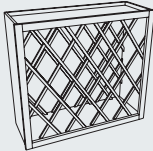

Criss Cross Wine Rack
Block 2100

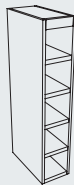

Wall Vertical Wine Rack
Block 2101
Works well in hobby rooms too, to organize yarn.

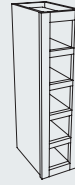

Wall Wine Cubes
Block 2102
Works well in hobby rooms too, to organize yarn.

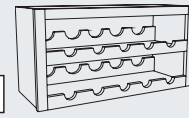

Wall Wine **Block 2103**

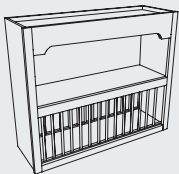

Wall Plate Rack
Block 2200
Ladder rack is removable for cleaning.



Wall Plate Rack
Block 2201
Ladder rack is removable for cleaning.

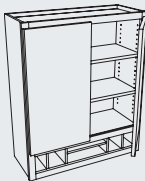

Organizer
Block 2300

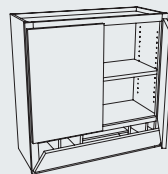

Organizer with
Flip Down Header
Block 2310

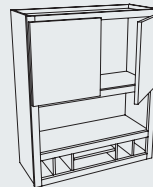

Organizer with Book
Shelf **Block 2330**



KITCHEN ORGANIZERS and STORAGE

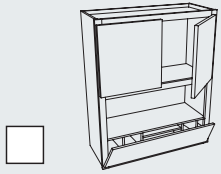

Organizer with Book Shelf and Flip Down Header **Block 2340**

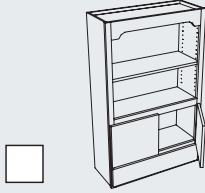

Combination Bookcase with Drawer **Block 2700**

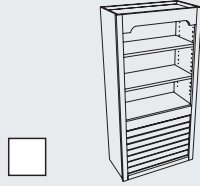

Bookcase with Tambour **Block 2720**

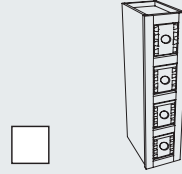

Apothecary Drawers Vertical with Dovetails **Block 2888**

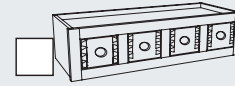

Apothecary Drawers with Dovetails **Block 2889**

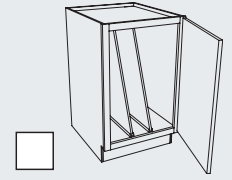

Tray Base **Block 3030**

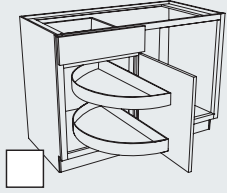

Blind Corner with Revolving Shelf **Block 3155**

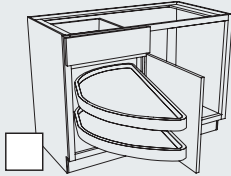

Blind Corner with Revolving Slide Out Wood Shelves **Block 3156**

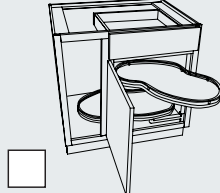

Blind Corner with Swing-out Shelf **Block 3157**

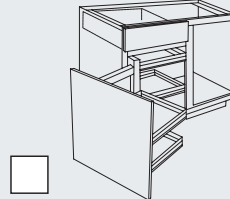

Blind Corner Pantry with Chrome/Wood Baskets **Block 3158**

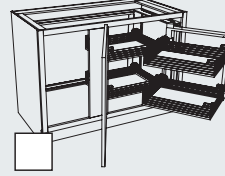

Blind Corner with Magic Corner Shelves **Block 3159**

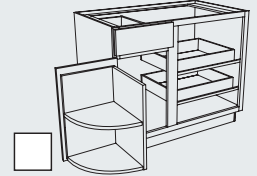

Blind Corner with Roll Out Trays and Door Shelf **Block 3160**

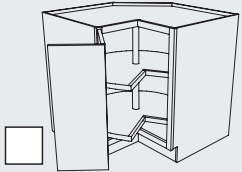

Square Lazy Susan Base **Block 3325**

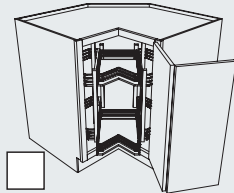

Square Base Corner with Revolving Slide Shelf **Block 3335**

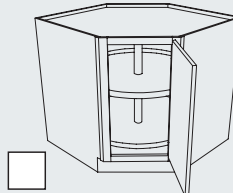

Diagonal Corner Lazy Susan **Block 3345**

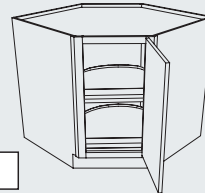

Diagonal Corner Lazy Susan with Wood Turntables **Block 3346**

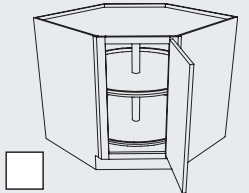

Diagonal Lazy Susan with Chrome/Wood Turntables **Block 3347**

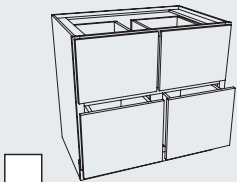

Four Deep Drawer Base **Block 3423**

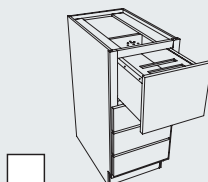

Drawer Base with Bread Liner in Top **Block 3442**

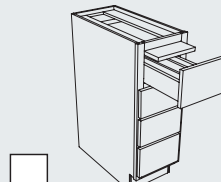

Drawer Base with Bread Board and Utensil Storage **Block 3460**

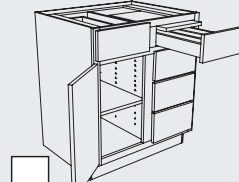

Four Drawer Combination with Bread Board and Utensil Storage **Block 3950**

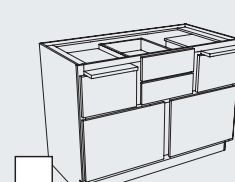

Base Pantry **Block 3975**

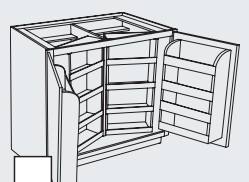

Base Canned Goods Storage **Block 3980**

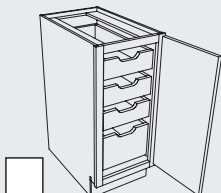

Base Full Height Door with Tall Roll Out Trays **Block 4000**

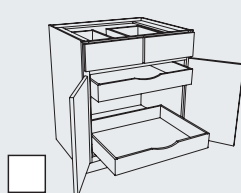

Base with Roll Out Trays **Block 4010**

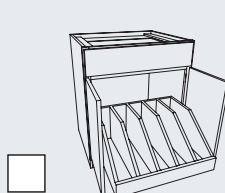

Base with Roll Out Tray Divider **Block 4020**

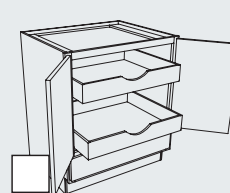

Range Base Reverse with Roll Out Trays **Block 4040**

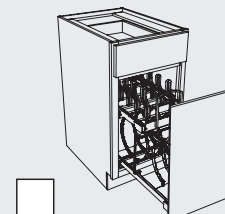

Range Mate **Block 4060**

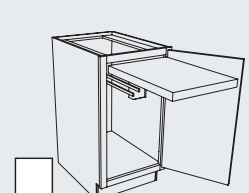

Base Mixer Shelf **Block 4065**
Fits KitchenAid Professional Series mixers. Some mixers can be attached to the shelf.

KITCHEN ORGANIZERS and STORAGE

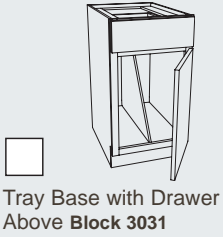

Tray Base with Drawer Above **Block 3031**

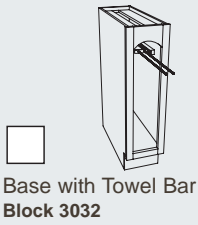

Base with Towel Bar **Block 3032**

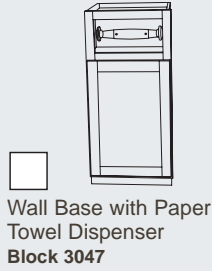

Wall Base with Paper Towel Dispenser **Block 3047**



Wall Base Tall with Paper Towel Dispenser **Block 3048**



Sink/Range Base with Drawer Front Bin **Block 3053**



Sink/Range Base with Spice Shelves **Block 3057**



Blind Corner with Revolving Slide Out Drawer Fronts **Block 3162**



Lazy Susan Base **Block 3220**

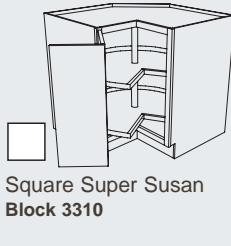

Square Super Susan **Block 3310**

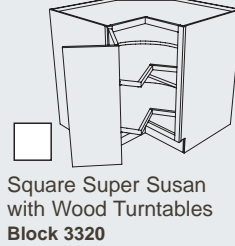

Square Super Susan with Wood Turntables **Block 3320**

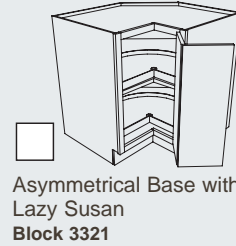

Asymmetrical Base with Lazy Susan **Block 3321**

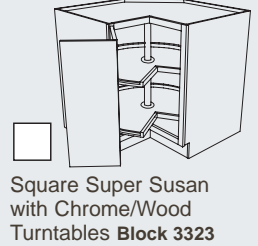

Square Super Susan with Chrome/Wood Turntables **Block 3323**

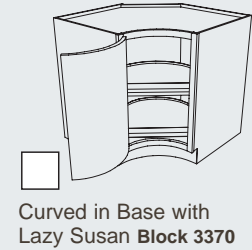

Curved in Base with Lazy Susan **Block 3370**

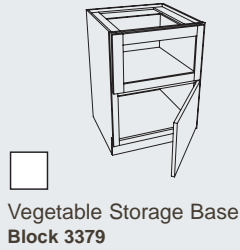

Vegetable Storage Base **Block 3379**

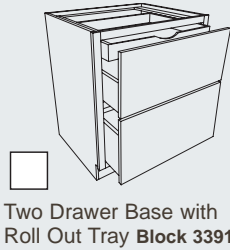

Two Drawer Base with Roll Out Tray **Block 3391**

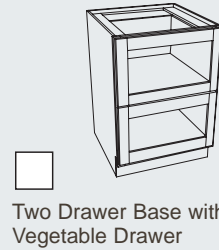

Two Drawer Base with Vegetable Drawer **Block 3392**

Works well in dressers too, so contents are visible.

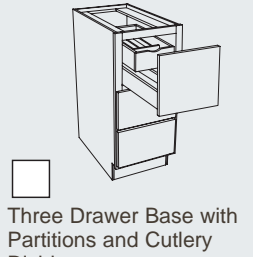

Three Drawer Base with Partitions and Cutlery Divider **Block 3418**

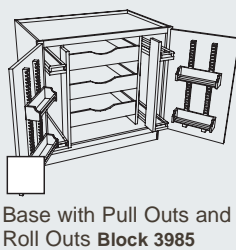

Base with Pull Outs and Roll Outs **Block 3985**



Base with Mini Pantry **Block 3990**



Base Full Height Pantry With Motion Drive Opening **Block 3992**



Base Pull Out Knife And Utensil Storage **Block 3993**

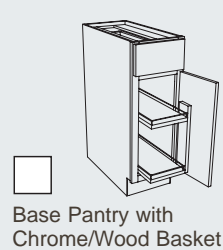

Base Pantry with Chrome/Wood Basket Shelves **Block 3995**

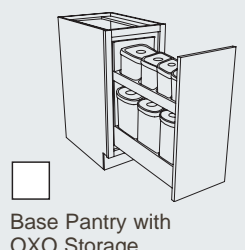

Base Pantry with OXO Storage **Block 3997**

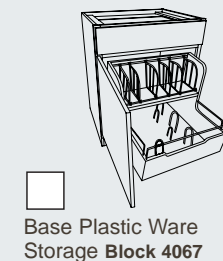

Base Plastic Ware Storage **Block 4067**

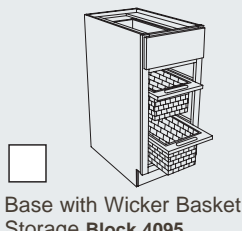

Base with Wicker Basket Storage **Block 4095**



Kitchen Waste Basket **Block 4100**

Works well in mudrooms and laundry rooms too, to hold pet food, bird seed, potting soil, cat litter.



Kitchen Basket Large **Block 4102**

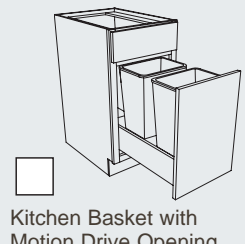

Kitchen Basket with Motion Drive Opening **Block 4106**

KITCHEN ORGANIZERS and STORAGE

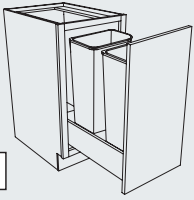

Kitchen Basket Large with Motion Drive Opening **Block 4108**

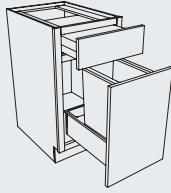

Kitchen Waste Basket with Chopping Block **Block 4110**

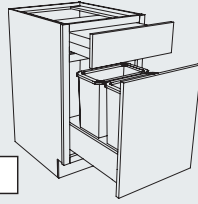

Kitchen Basket with Motion Drive Opening and Chopping Block **Block 4112**

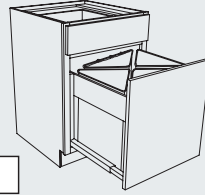

Recycle Base **Block 4130**
Works well in mudrooms and laundry rooms too, to hold pet food and bird seed.

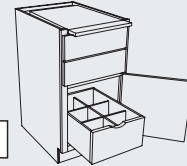

Bar Maid **Block 4140**

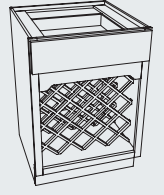

Base with Wine Rack Below Drawer **Block 4399**

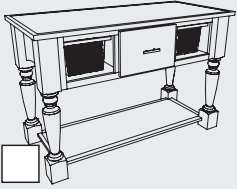

Base Island Unit Style A **Block 4426**
Works well for creating custom vanities too.

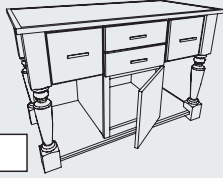

Base Island Unit Style B **Block 4427**
Works well for creating custom vanities too.

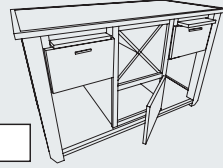

Base Island Unit Style C **Block 4428**
Works well for creating custom vanities too.

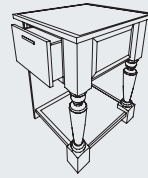

Base Island Unit Style D **Block 4429**
Works well for creating custom vanities too.

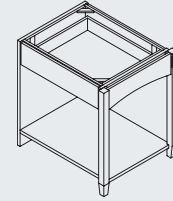

Base Island Assembly Style A **Block 4430**



Base Vertical Apothecary Drawer **Block 4450**

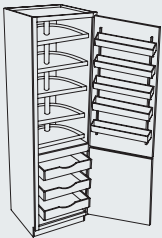

Chef's Pantry with Wood Turntables **Block 5101**
Works well in hobby rooms too.

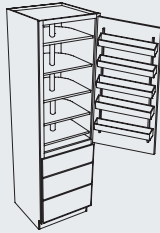

Chef's Pantry with Drawers **Block 5110**
Works well in hobby rooms too.

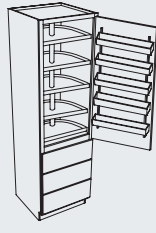

Chef's Pantry with Drawers and Wood Turntables **Block 5111**
Works well in hobby rooms too.

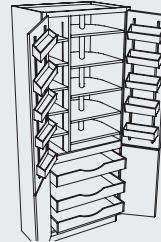

Super Chef's Pantry **Block 5120**
Works well in hobby rooms too.

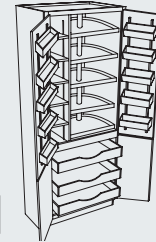

Super Chef's Pantry with Wood Turntables **Block 5121**
Works well in hobby rooms too.

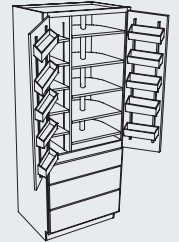

Super Chef's Pantry with Drawers **Block 5130**
Works well in hobby rooms too.

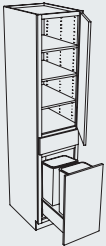

Utility with Waste Bin **Block 5198**

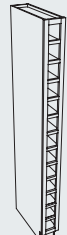

Wine Cube Utility **Block 5505**

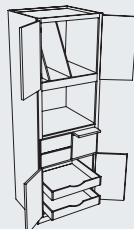

Microwave Cook Center **Block 6100**

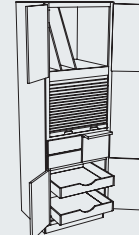

Microwave Tambour Cook Center **Block 6110**

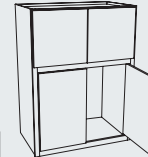

Entertainment Wall Pocket Door **Block 7020**

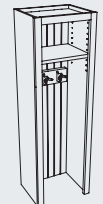

Wall Locker **Block 7025**

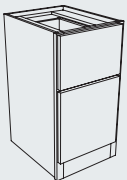

File Two Drawer Base **Block 7290**

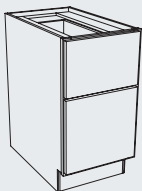

Desk File Drawer Base **Block 7295**

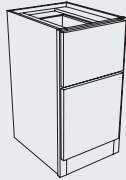

Desk File Drawer Base with Wide Bottom Rail **Block 7300**



Tall Locker **Block 7550**



Tall Locker Stacked **Block 7555**

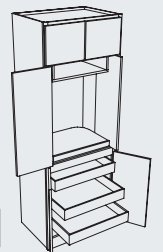

Tall Entertainment Pocket Door with Wide Bottom Rail **Block 7910**

KITCHEN ORGANIZERS and STORAGE

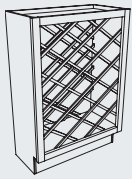

Wall Base Criss Cross Wine Rack **Block 4400**

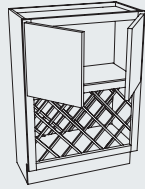

Wall Base with Wine Rack Below Doors **Block 4401**

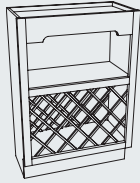

Wall Base with Wine Rack Below Open Shelf **Block 4402**

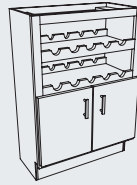

Wall Base Wine Rack **Block 4405**

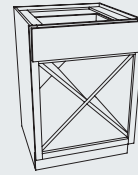

Base Wine Diagonal **Block 4411**

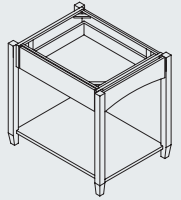

Base Island Unit **Block 4425**



Base Vertical Wine Rack **Block 4460**
Works well in home offices too, to hold blueprint drawings.

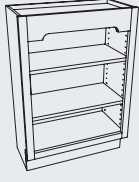

Open Shelf Wall Base **Block 4630**



Broom Storage Base **Block 5030**
In wider widths, works well in Master Suites too, when a pole is installed for hanging clothes.

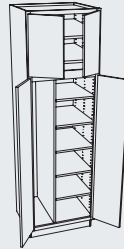

Utility and Broom Combination **Block 5031**

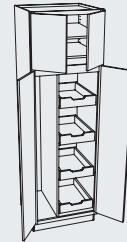

Utility Broom and Roll Tray Combination **Block 5032**

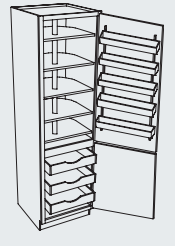

Chef's Pantry **Block 5100**
Works well in hobby rooms too.

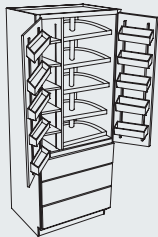

Super Chef's Pantry with Drawers and Wood Turntables **Block 5131**
Works well in hobby rooms too.

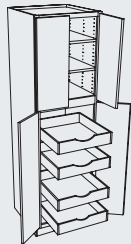

Utility with Roll Out Trays **Block 5150**
Works well in hobby rooms too.

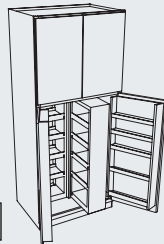

Utility Canned Goods Storage **Block 5180**
Works well in hobby rooms too.

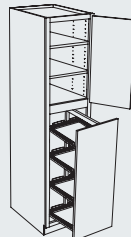

Utility Pull Out Pantry with Soft Close **Block 5185**

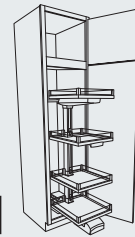

Utility Pantry with Lavid Pull Out **Block 5187**

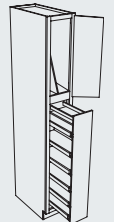

Utility Pull Out Pantry **Block 5190**

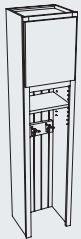

Wall Locker Stacked **Block 7030**

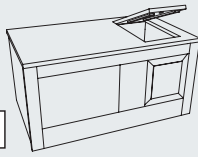

Blind Corner Window Chest **Block 7060**

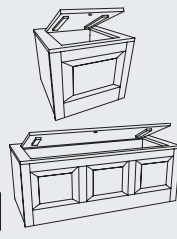

Base Window Chest **Block 7062**

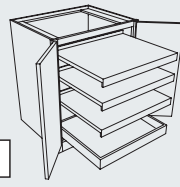

Music Center with Roll Out Shelves and Wide Bottom Rail **Block 7200**

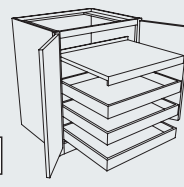

Media Center with Roll Out Shelves and Wide Bottom Rail **Block 7210**

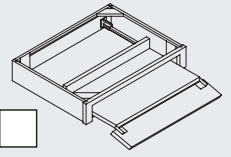

Pull Out Keyboard **Block 7285**

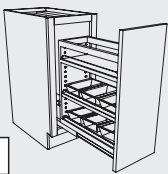

Vanity Organizer **Block 8085**
Works well in hobby rooms too.

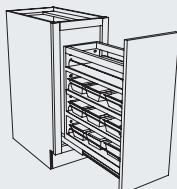

Tall Vanity Organizer **Block 8185**
Works well in hobby rooms too.

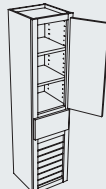

Vanity Tambour Wall **Block 8205**

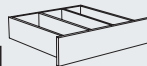

Drawer Partitions **Block 9214**

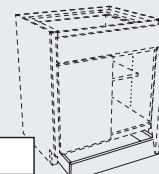

Toe Kick Drawer **Block 9215**

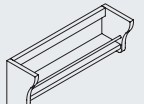

Wall Spice Shelf **Block 10090**

KITCHEN ORGANIZERS and STORAGE

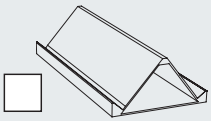

Spice Rack for Base with Mini Pantry Block 10150

Works well for cosmetics and nail polish in a bathroom, and paint and bead containers in a hobby room.

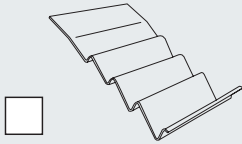

Wood Spice Rack Organizer Block 10160

Works well for cosmetics and nail polish in a bathroom, and paint and bead containers in a hobby room.

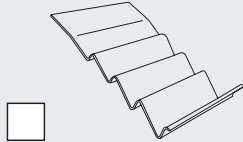

Drawer Spice Rack Block 10170

Works well for cosmetics and nail polish in a bathroom, and paint and bead containers in a hobby room.

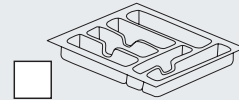

Plastic Cutlery Divider Block 10190

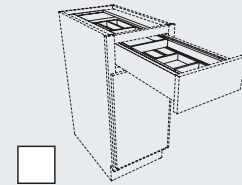

Cutlery Tiered Rack Block 10200

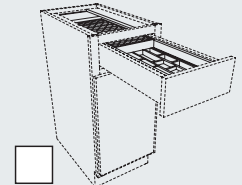

Beverage Pod Tiered Rack Block 10202

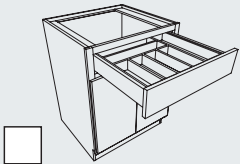

Cutlery Expandable Rack Block 10210

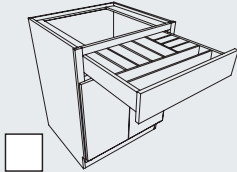

All-Wood Drawer Organizer Block 10220

Re-arrange the dividers to fit your stuff.

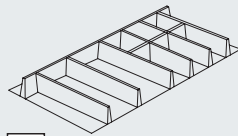

Wood Cutlery Divider Block 10225

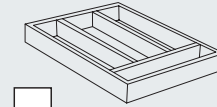

Cutlery Divider Box Block 10230

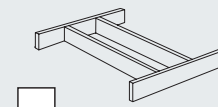

Cutlery Divider Block 10240

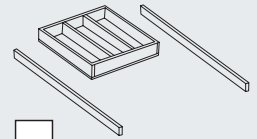

Cutlery Wood Rack Block 10250

The Cutlery Wood Rack is a divided box that rests on runners, creating two tiers, so there's more space in the same footprint.

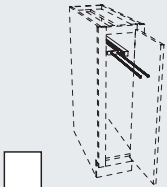

Sliding Towel Bar Kit Block 10260

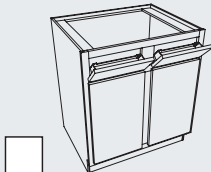

Drawer Front Bins Block 10270

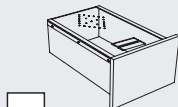

Bread Liner Block 10280

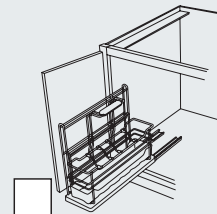

Sink Base Caddy Block 10265

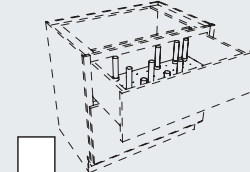

Drawer Organizer Block 10290

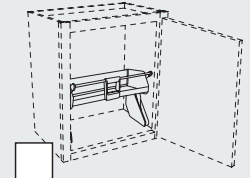

Wall Pull Down Pantry Single Shelf Kit Block 10321

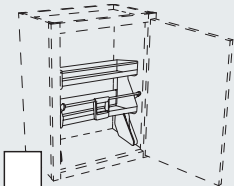

Wall Pull Down Pantry Double Shelf Kit Block 10322

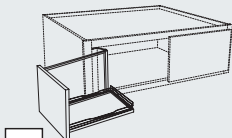

Over Appliance Pull Out Block 10323

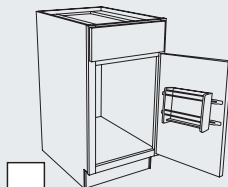

Door Mount Aluminum Foil Rack Holder Block 10325

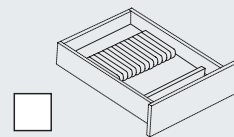

Knife Block Block 10410

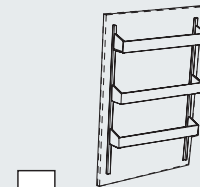

Spice Shelf Kit Block 10440

Works well for cosmetics and nail polish in a bathroom, and paint and bead containers in a hobby room.

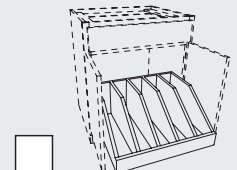

Roll Out Tray Divider Block 10490

Works well in home offices too, to hold manuals, catalogs and software.

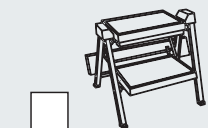

Folding Step Block 10500

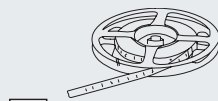

LED Strip Lighting Block 10557

Works well under wall cabinets, base cabinets and vanity cabinets and for lighting display areas.

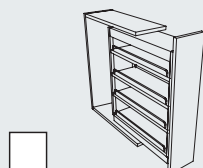

Pull Out Filler Storage Block 11110

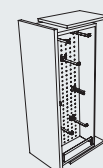

Pull Out Peg Storage Block 11120

Works well in a mudroom for holding keys.

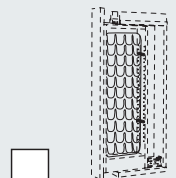

Beverage Pod Accessory for Wall Pull Out Filler Storage Block 11108



HOME BAR ORGANIZERS and STORAGE

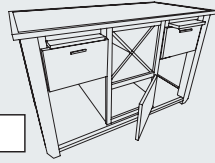

Base Island Unit
Style C Block 4428

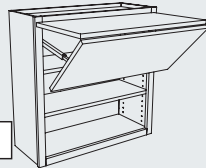

Wall Cabinet with
Bifold Door Block 1120

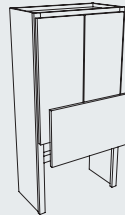

Wall with Appliance Door
Vertical Lift Up
Block 2002

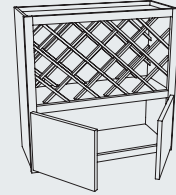

Criss Cross Wine Rack
above Doors Block 2098

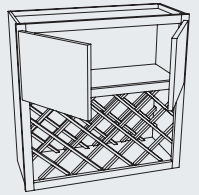

Criss Cross Wine Rack
below Doors Block 2099

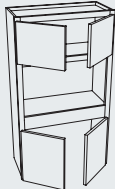

Microwave Garage with
Appliance Doors
Block 2071

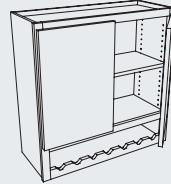

Wall with Wine Rack
Bottom Block 2110

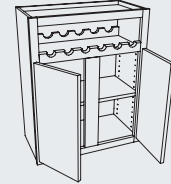

Wall with Wine Rack Top
Block 2120

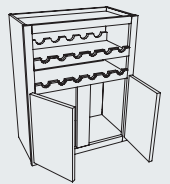

Wall with Double Wine
Rack Top Block 2130

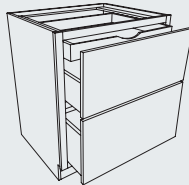

Two Drawer Base with
Roll Out Tray Block 3391

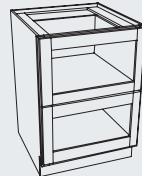

Two Drawer Base with
Vegetable Drawer
Block 3392

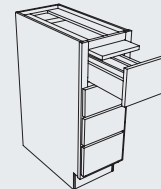

Drawer Base with
Bread Board and
Utensil Storage
Block 3460

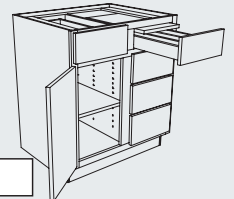

Four Drawer
Combination with
Bread Board and
Utensil Storage
Block 3950

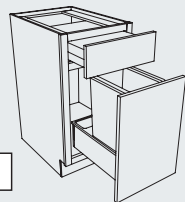

Kitchen Waste Basket
with Chopping Block
Block 4110

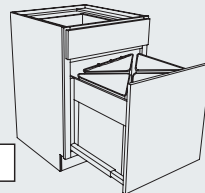

Recycle Base
Block 4130

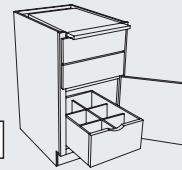

Bar Maid
Block 4140

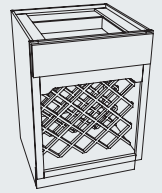

Base with Wine Rack
Below Drawer Block 4399

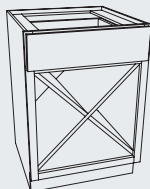

Base Wine Diagonal
Block 4411



Base Vertical Wine Rack
Block 4460

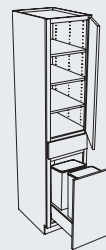

Utility with Waste Bin
Block 5198

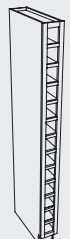

Wine Cube Utility
Block 5505

HOME BAR ORGANIZERS and STORAGE

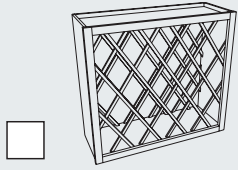

Criss Cross Wine Rack
Block 2100

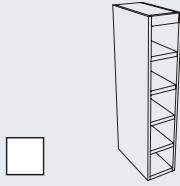

Wall Vertical Wine Rack
Block 2101

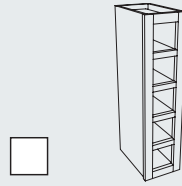

Wall Wine Cubes
Block 2102

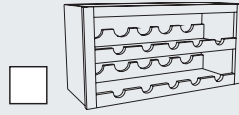

Wall Wine Block 2103

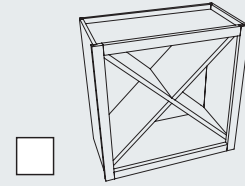

Wall Wine Diagonal
Block 2104

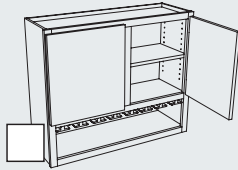

Wall with Stem Glass
Rack Block 2140

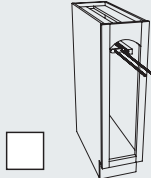

Base with Towel Bar
Block 3032

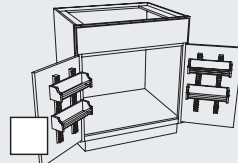

Sink/Range Base with
Spice Shelves
Block 3057

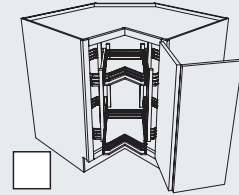

Square Base Corner with
Revolving Slide Shelf
Block 3335

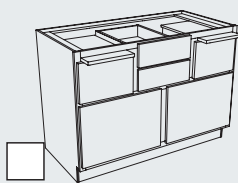

Base Pantry
Block 3975

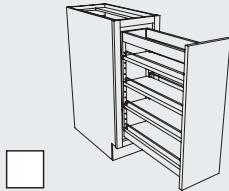

Base with Mini Pantry
Block 3990

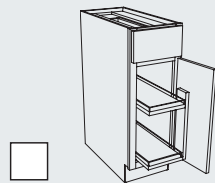

Base Pantry with
Chrome/Wood Basket
Shelves Block 3995

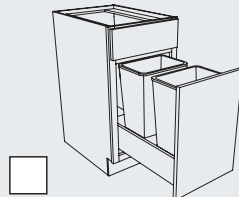

Kitchen Basket with
Motion Drive Opening
Block 4106

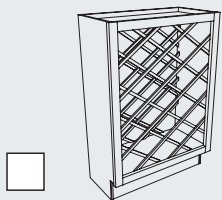

Wall Base Criss Cross
Wine Rack Block 4400

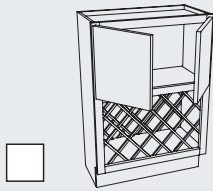

Wall Base with Wine
Rack Below Doors
Block 4401

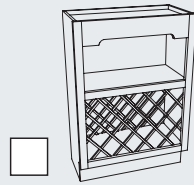

Wall Base with Wine
Rack Below Open Shelf
Block 4402

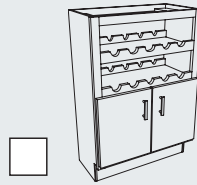

Wall Base Wine Rack
Block 4405

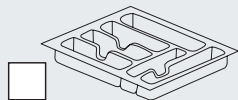

Plastic Cutlery Divider
Block 10190

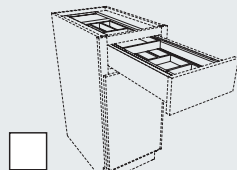

Cutlery Tiered Rack
Block 10200

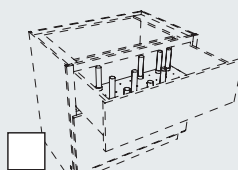

Drawer Organizer
Block 10290

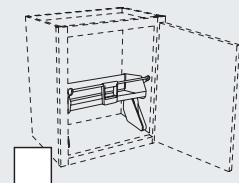

Wall Pull Down Pantry
Single Shelf Kit
Block 10321



BATHROOM ORGANIZERS and STORAGE

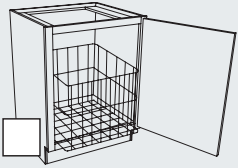

Vanity Hamper
Block 8055

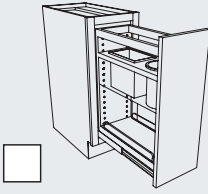

Vanity Grooming
Organizer Block 8080

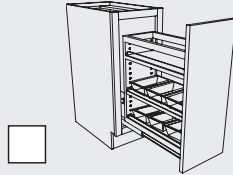

Vanity Organizer
Block 8085

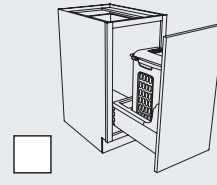

Vanity Hamper Pull Out
Block 8155

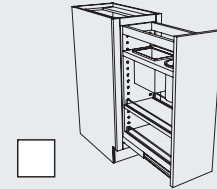

Tall Vanity Grooming
Organizer Block 8180

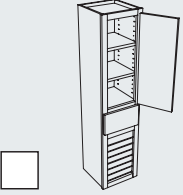

Vanity Tambour Wall
Block 8205

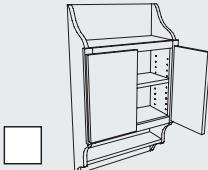

Toilet Topper
Block 8215

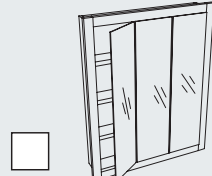

Vanity Tri Mirror
Block 8315

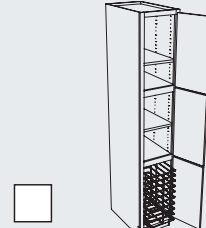

Linen with Hamper
Block 8500

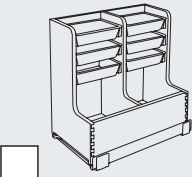

L Shaped Vanity
Organizer
Block 10266

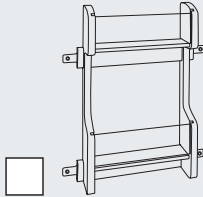

Vanity Door Mounted
Storage Rack
Block 10326

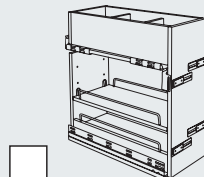

Vanity Pull Out Kit
Block 10334

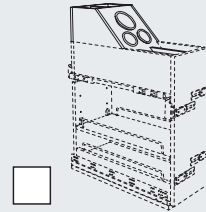

Grooming Kit
Block 10335

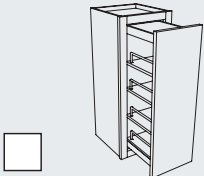

Wall Pantry Block 1102

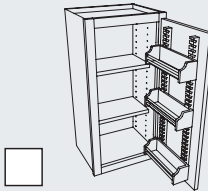

Spice Shelf Wall
Block 1110

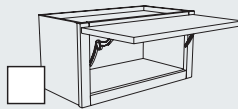

Wall Cabinet with
Tip Up Door Block 1115

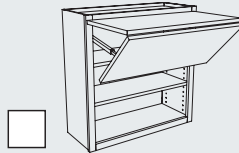

Wall Cabinet with
Bifold Door Block 1120

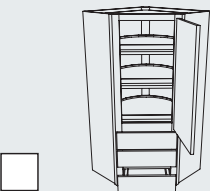

Diagonal Wall with Wood
Turntables and Drawers
Block 1534

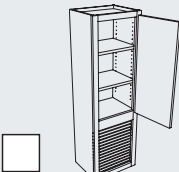

Wall with Tambour
Block 2000

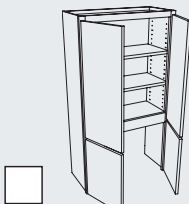

Wall with Appliance Door
Block 2001

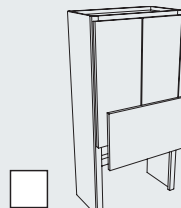

Wall with Appliance Door
Vertical Lift Up Block 2002



BATHROOM ORGANIZERS and STORAGE

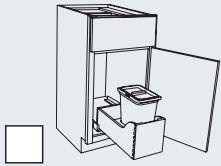

Vanity Waste
Block 8160

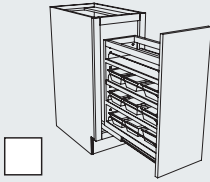

Tall Vanity Organizer
Block 8185

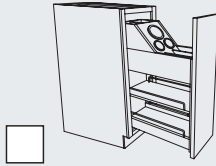

Vanity Pull Out Grooming
Block 8190

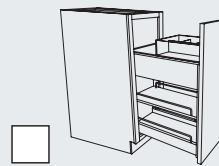

Vanity Pull Out with
Acrylic Tray
Block 8192

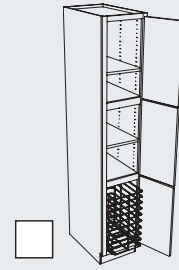

Linen with Hamper
Block 8505

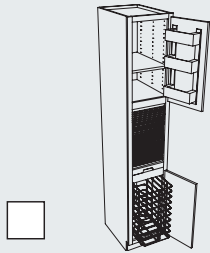

Linen with Tambour
and Hamper Block 8510

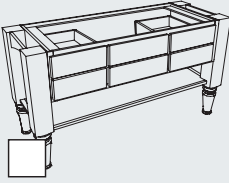

Spa Vanity Six Drawer
Front Combination with
Plinth Shelf Block 8769

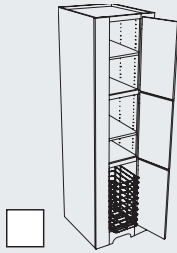

Tailored Linen Hamper
with Wide Stiles
Block 8902

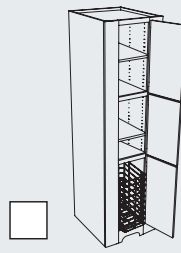

Tailored Tall Linen
Hamper with Wide Stiles
Block 8907

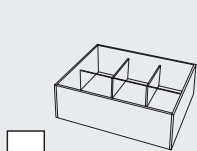

Acrylic Tray
Block 10336

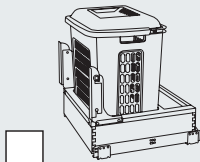

Vanity Hamper Pull Out
Block 10511

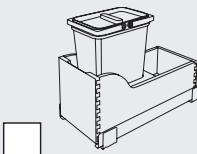

Vanity Waste Container
Block 10527

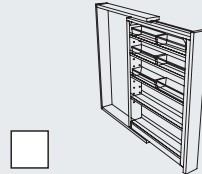

Vanity Pull Out Filler
Storage Block 11110

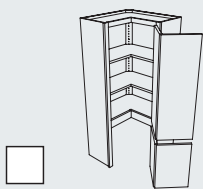

Square Corner Wall with
Appliance Door
Block 1415

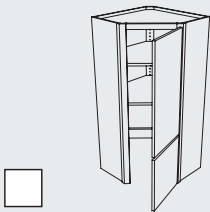

Diagonal Wall with Door
Block 1516

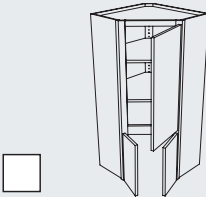

Deep Diagonal Wall with
Butt Doors
Block 1518

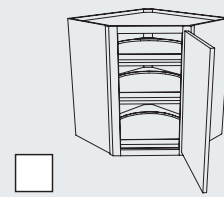

Diagonal Wall with
Wood Turntables
Block 1522

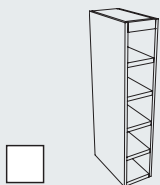

Wall Vertical Wine Rack
Block 2101

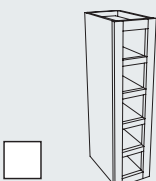

Wall Wine Cubes
Block 2102

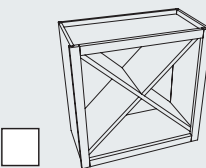

Wall Wine Diagonal
Block 2104

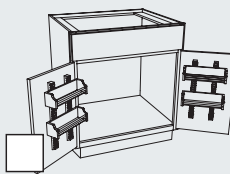

Sink/Range Base with
Spice Shelves
Block 3057



BATHROOM ORGANIZERS and STORAGE

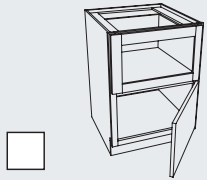

Vegetable Storage Base
Block 3379

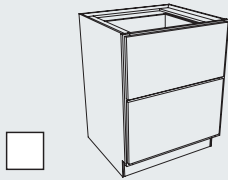

Two Drawer Base
Block 3390

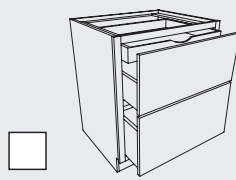

Two Drawer Base with
Roll Out Tray Block 3391

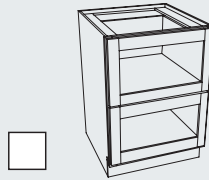

Two Drawer Base with
Vegetable Drawer
Block 3392

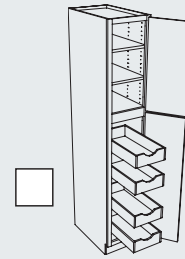

Utility with Roll Out Trays Block 5150

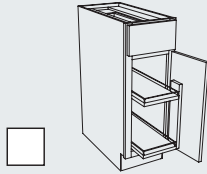

Base Pantry with
Chrome/Wood Basket
Shelves Block 3995

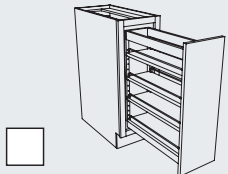

Base with Mini Pantry
Block 3990

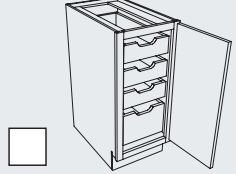

Base Full Height Door
with Tall Roll Out Trays
Block 4000

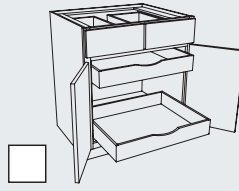

Base with Roll Out Trays
Block 4010

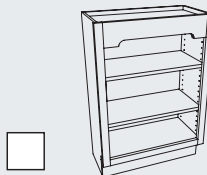

Open Shelf Wall Base
Block 4630

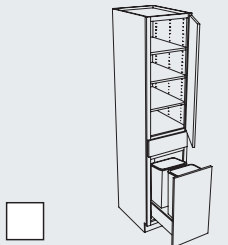

Utility with Waste Bin
Block 5198

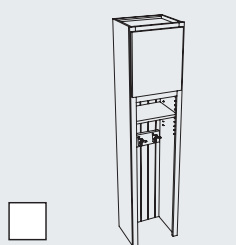

Wall Locker Stacked
Block 7030
Hooks work well for bath
robes and towels.

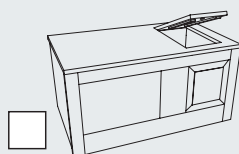

Blind Corner Window
Chest Block 7060

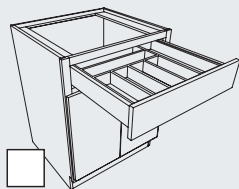

Cutlery Expandable Rack
Block 10210

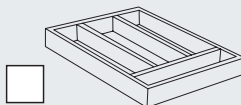

Cutlery Divider Box
Block 10230

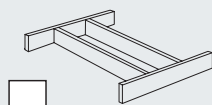

Cutlery Divider
Block 10240

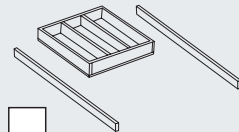

Cutlery Wood Rack
Block 10250
The Cutlery Wood Rack is
a divided box that rests on
runners, creating two tiers,
so there's more space in the
same footprint.

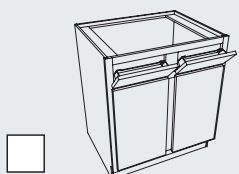

Drawer Front Bins
Block 10270

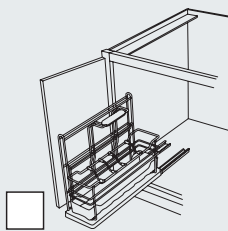

Sink Base Caddy
Block 10265

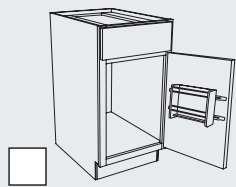

Door Mount Aluminum
Foil Rack Holder
Block 10325

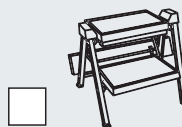

Folding Step
Block 10500



BATHROOM ORGANIZERS and STORAGE

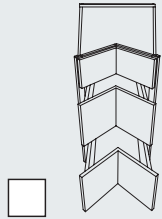

□ Square Base Corner with Drawers **Block 3337**

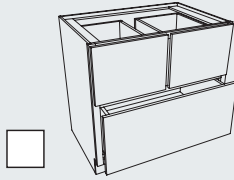

□ Three Deep Drawer Base **Block 3422**

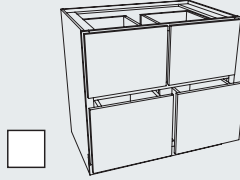

□ Four Deep Drawer Base **Block 3423**

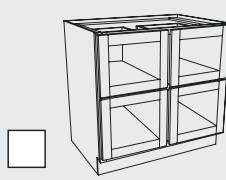

□ Four Drawer Base with Vegetable Front **Block 3424**

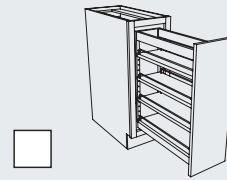

□ Pull Out Pantry With Soft Close **Block 3991**

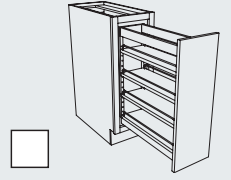

□ Base Full Height Pantry With Motion Drive Opening **Block 3992**

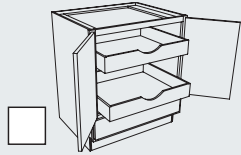

□ Range Base Reverse with Roll Out Trays **Block 4040**

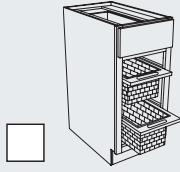

□ Base with Wicker Basket Storage **Block 4095**

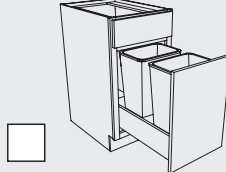

□ Kitchen Waste Basket **Block 4100**

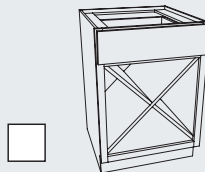

□ Base Wine Diagonal **Block 4411**

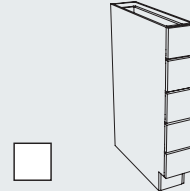

□ Base Vertical Apothecary Drawer **Block 4450**

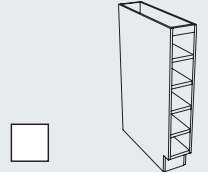

□ Base Vertical Wine Rack **Block 4460**

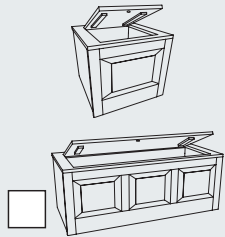

□ Base Window Chest **Block 7062**

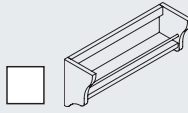

□ Wall Spice Shelf **Block 10090**

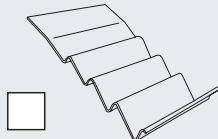

□ Wood Spice Rack Organizer **Block 10160**
Works well for cosmetics and nail polish.

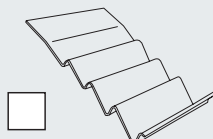

□ Drawer Spice Rack **Block 10170**
Works well for cosmetics and nail polish.

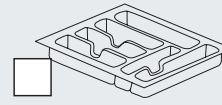

□ Plastic Cutlery Divider **Block 10190**

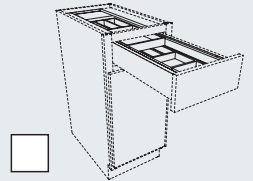

□ Cutlery Tiered Rack **Block 10200**

Endless storage options with vanity drawer organizers

New!



□ Single Vanity Drawer Organizer **Block 10204**



□ Tiered Vanity Drawer Organizer **Block 10205**



□ Half Tiered Vanity Drawer Organizer **Block 10206**

The non-slip liners hold contents in place and are easy to clean. Removeable bins are perfect for makeup, cotton swabs, grooming accessories and more!

MEDIA ROOM & FAMILY ROOM ORGANIZERS and STORAGE

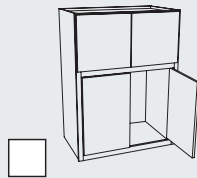

Entertainment Wall Pocket Door Block 7020

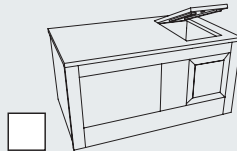

Blind Corner Window Chest Block 7060

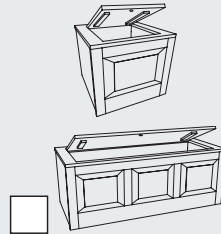

Base Window Chest Block 7062

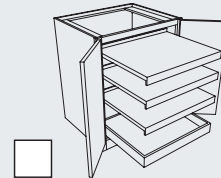

Music Center with Roll Out Shelves and Wide Bottom Rail Block 7200

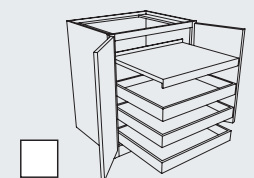

Media Center with Roll Out Shelves and Wide Bottom Rail Block 7210

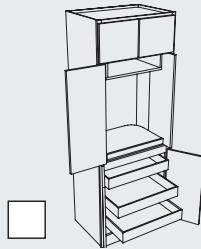

Tall Entertainment Pocket Door with Wide Bottom Rail Block 7910



Refrigerator Wall with Tip Up Door Block 1081

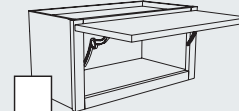

Wall Cabinet with Tip Up Door Block 1115

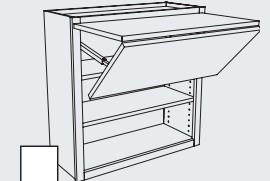

Wall Cabinet with Bifold Door Block 1120

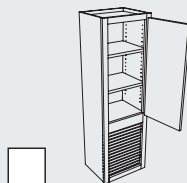

Wall with Tambour Block 2000

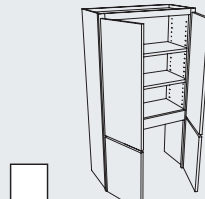

Wall with Appliance Door Block 2001

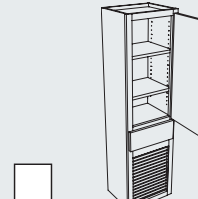

Wall with Tambour and Drawer Block 2010

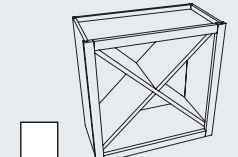

Wall Wine Diagonal Block 2104

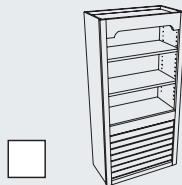

Bookcase with Tambour Block 2720

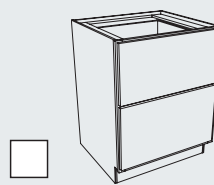

Two Drawer Base Block 3390

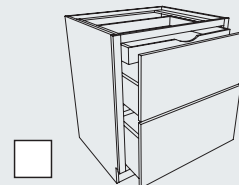

Two Drawer Base with Roll Out Tray Block 3391

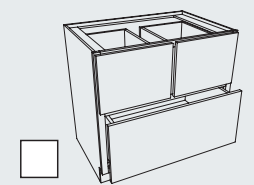

Three Deep Drawer Base Block 3422

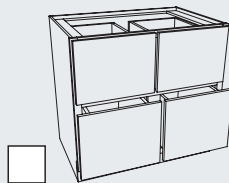

Four Deep Drawer Base Block 3423

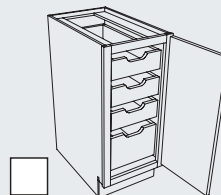

Base Full Height Door with Tall Roll Out Trays Block 4000

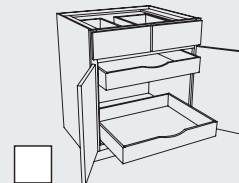

Base with Roll Out Trays Block 4010

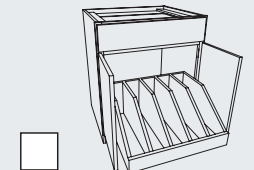

Base with Roll Out Tray Divider Block 4020

CLOSET & MASTER SUITE ORGANIZERS and STORAGE

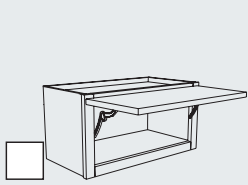

Wall Cabinet with Tip Up Door **Block 1115**

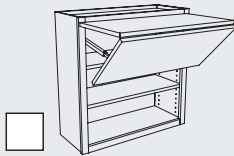

Wall Cabinet with Bifold Door **Block 1120**

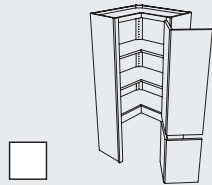

Square Corner Wall with Appliance Door **Block 1415**

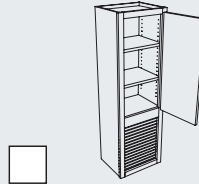

Wall with Tambour **Block 2000**

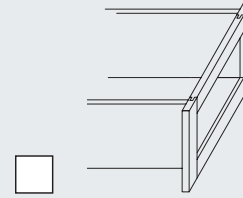

Vegetable Storage Drawer **Block 9820**
Works well in dressers too, so contents are visible.

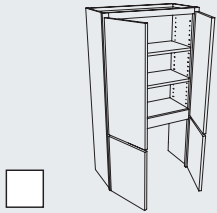

Wall with Appliance Door **Block 2001**

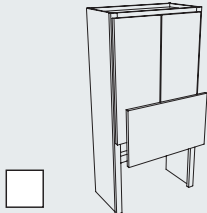

Wall with Appliance Door Vertical Lift Up **Block 2002**

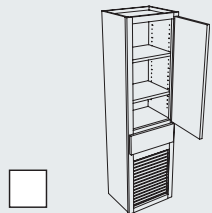

Wall with Tambour and Drawer **Block 2010**

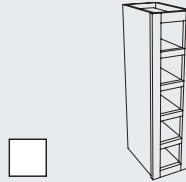

Wall Wine Cubes **Block 2102**

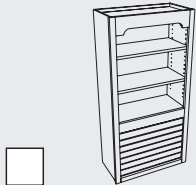

Bookcase with Tambour **Block 2720**

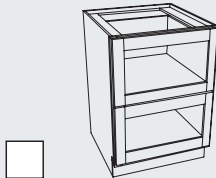

Two Drawer Base with Vegetable Drawer **Block 3392**
Works well in dressers too, so contents are visible.

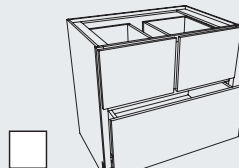

Three Deep Drawer Base **Block 3422**

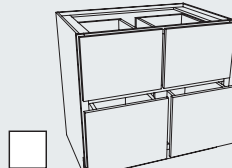

Four Deep Drawer Base **Block 3423**

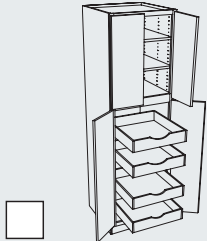

Utility with Roll Out Trays **Block 5150**

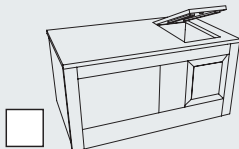

Blind Corner Window Chest **Block 7060**



Base Window Chest **Block 7062**

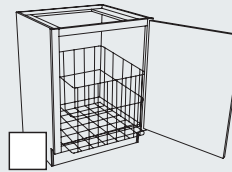

Vanity Hamper **Block 8055**

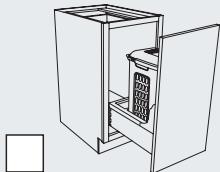

Vanity Hamper Pull Out **Block 8155**

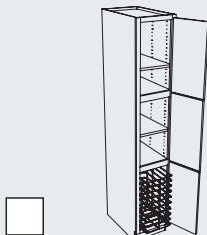

Linen with Hamper **Block 8500**

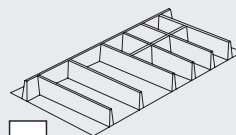

Wood Cutlery Divider **Block 10225**

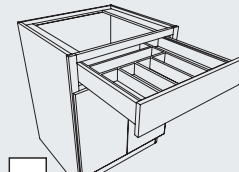

Cutlery Expandable Rack **Block 10210**



HOME OFFICE & HOBBY ROOM ORGANIZERS and STORAGE

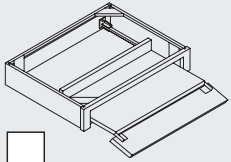

Pull Out Keyboard
Block 7285

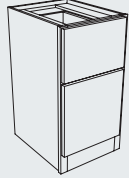

File Two Drawer Base
Block 7290

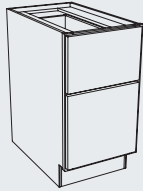

Desk File Drawer Base
Block 7295

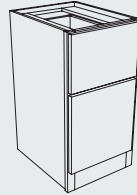

Desk File Drawer Base
with Wide Bottom Rail
Block 7300

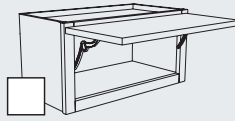

Wall Cabinet with
Tip Up Door Block 1115

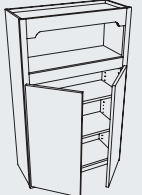

Stacked Wall Cabinet
with Open Shelf Above
Block 1146



Diagonal Wall with
Wood Turntables and
Door Block 1531

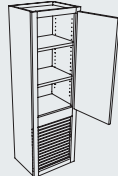

Wall with Tambour
Block 2000

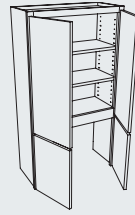

Wall with Appliance Door
Block 2001

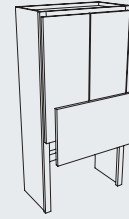

Wall with Appliance Door
Vertical Lift Up
Block 2002

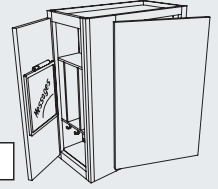

Wall Message Center
Block 2299



Combination Bookcase
with Drawer
Block 2700



Bookcase
Block 2705



Bookcase with Beaded
Back Block 2706



Bookcase with Tambour
Block 2720

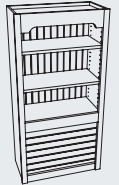

Bookcase with Tambour
and Beaded Back
Block 2721

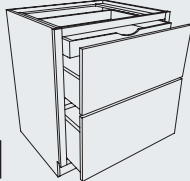

Two Drawer Base with
Roll Out Tray Block 3391

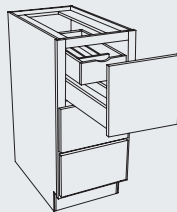

Three Drawer Base with
Partitions and Cutlery
Divider Block 3418

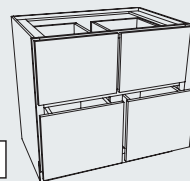

Four Deep Drawer Base
Block 3423

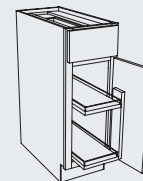

Base Pantry with
Chrome/Wood Basket
Shelves Block 3995

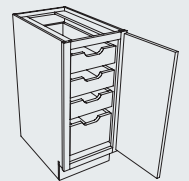

Base Full Height Door
with Tall Roll Out Trays
Block 4000

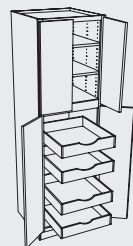

Utility with Roll Out Trays
Block 5150



Base Window Chest
Block 7062

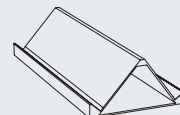

Spice Rack for Base with
Mini Pantry Block 10150
Works well for paint and
bead containers.

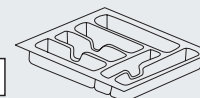

Plastic Cutlery Divider
Block 10190

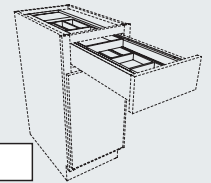

Cutlery Tiered Rack
Block 10200



HOME OFFICE & HOBBY ROOM ORGANIZERS and STORAGE

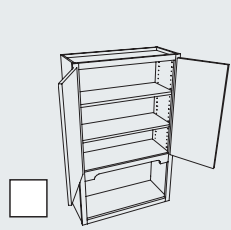

Stacked Wall Cabinet with Open Shelf Below
Block 1152

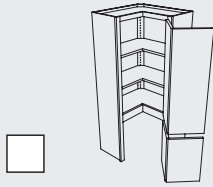

Square Corner Wall with Appliance Door
Block 1415

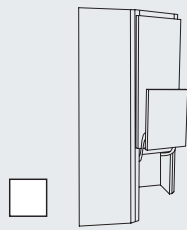

Diagonal Wall with Lift Up Door
Block 1506
Deep **Block 1507**

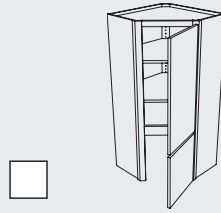

Diagonal Wall with Door
Block 1516

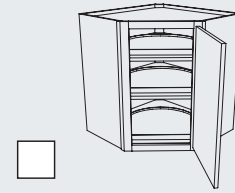

Diagonal Wall with Wood Turntables
Block 1522

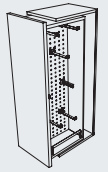

Pull Out Peg Storage
Block 11120

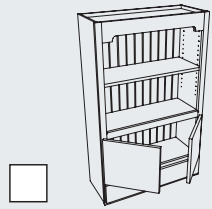

Combination Bookcase with Drawer and Beaded Back
Block 2701

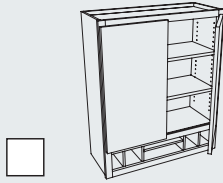

Organizer
Block 2300

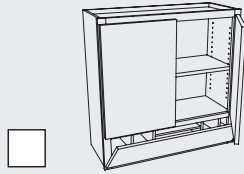

Organizer with Flip Down Header
Block 2310

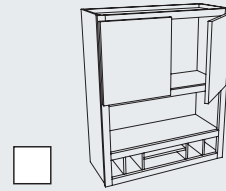

Organizer with Book Shelf
Block 2330

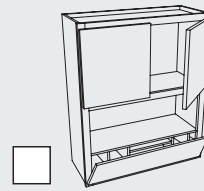

Organizer with Book Shelf and Flip Down Header
Block 2340

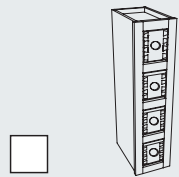

Apothecary Drawers Vertical with Dovetails
Block 2888

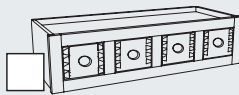

Apothecary Drawers with Dovetails
Block 2889

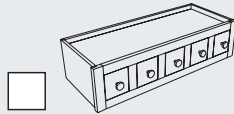

Apothecary Drawers
Block 2890

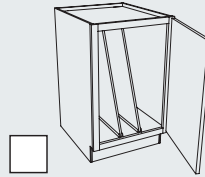

Tray Base **Block 3030**
Works well for organizing canvases and frames.

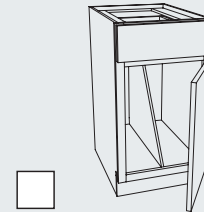

Tray Base with Drawer Above
Block 3031
Works well for organizing canvases and frames.

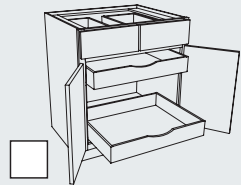

Base with Roll Out Trays
Block 4010

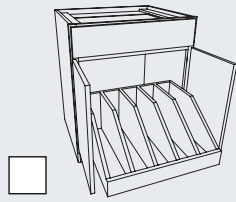

Base with Roll Out Tray Divider
Block 4020
Works well for organizing canvases and frames.

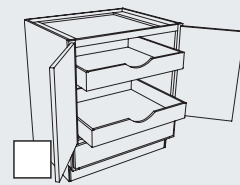

Range Base Reverse with Roll Out Trays
Block 4040

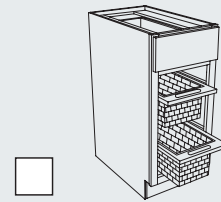

Base with Wicker Basket Storage
Block 4095

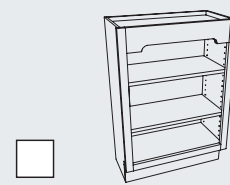

Open Shelf Wall Base
Block 4630

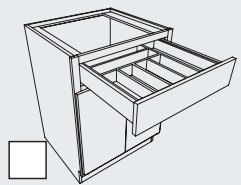

Cutlery Expandable Rack
Block 10210

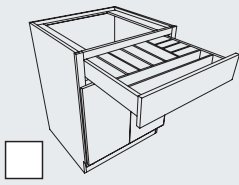

All-Wood Drawer Organizer
Block 10220
Re-arrange the dividers to fit your stuff.

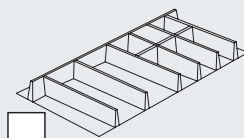

Wood Cutlery Divider
Block 10225

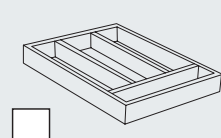

Cutlery Divider Box
Block 10230

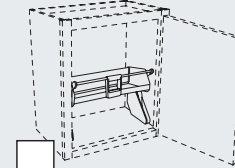

Wall Pull Down Pantry Single Shelf Kit
Block 10321



LAUNDRY ROOM & MUDROOM ORGANIZERS and STORAGE

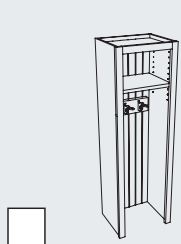

Wall Locker
Block 7025

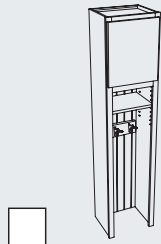

Wall Locker Stacked
Block 7030

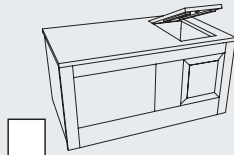

Blind Corner
Window Chest
Block 7060

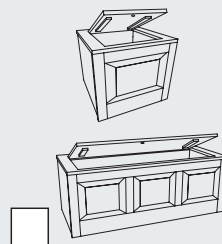

Base Window Chest
Block 7062

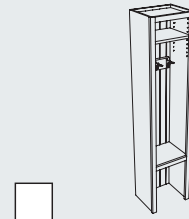

Tall Locker
Block 7550

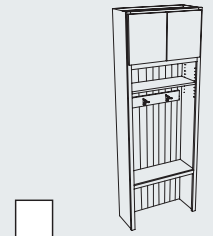

Tall Locker Stacked
Block 7555

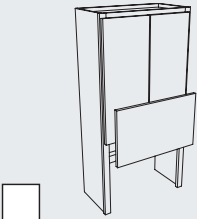

Wall with Appliance Door
Vertical Lift Up
Block 2002

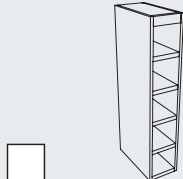

Wall Vertical Wine Rack
Block 2101

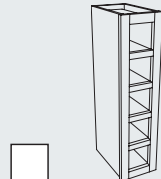

Wall Wine Cubes
Block 2102

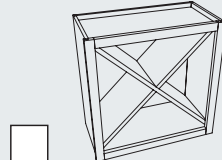

Wall Wine Diagonal
Block 2104

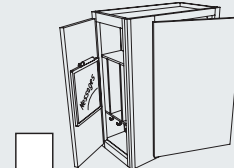

Wall Message Center
Block 2299

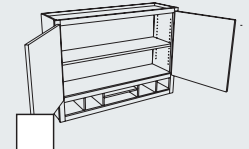

Organizer
Block 2300

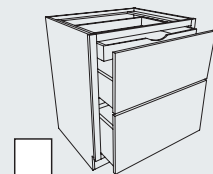

Two Drawer Base with
Roll Out Tray Block 3391

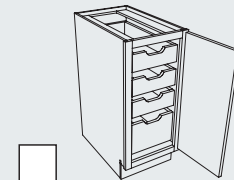

Base Full Height Door
with Tall Roll Out Trays
Block 4000

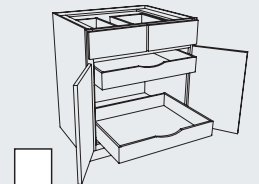

Base with Roll Out Trays
Block 4010

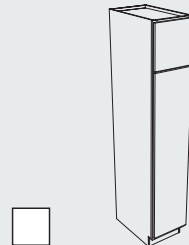

Broom Storage Base
Block 5030

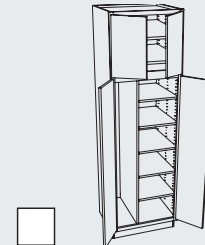

Utility and Broom
Combination Block 5031

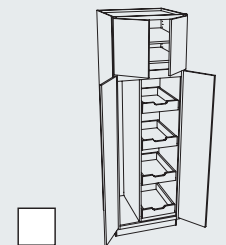

Utility Broom and Roll
Tray Combination
Block 5032

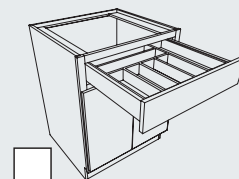

Cutlery Expandable Rack
Block 10210

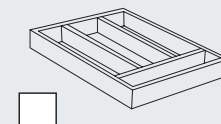

Cutlery Divider Box
Block 10230

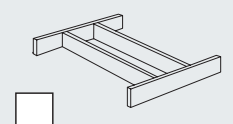

Cutlery Divider
Block 10240

LAUNDRY ROOM & MUDROOM ORGANIZERS and STORAGE

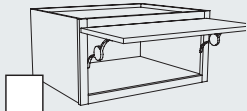

Refrigerator Wall with Tip Up Door **Block 1081**

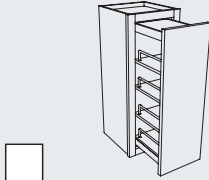

Wall Pantry **Block 1102**



Wall Cabinet with Tip Up Door **Block 1115**

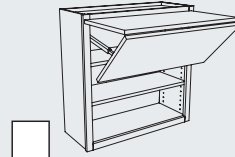

Wall Cabinet with Bifold Door **Block 1120**

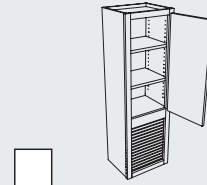

Wall with Tambour **Block 2000**

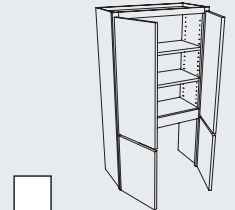

Wall with Appliance Door **Block 2001**

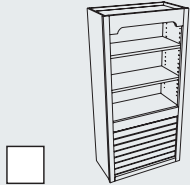

Bookcase with Tambour **Block 2720**

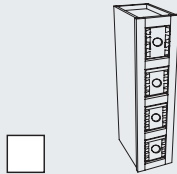

Apothecary Drawers Vertical with Dovetails **Block 2888**

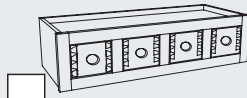

Apothecary Drawers with Dovetails **Block 2889**

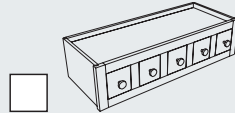

Apothecary Drawers **Block 2890**

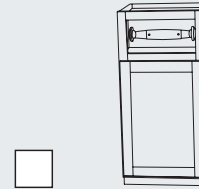

Wall Base with Paper Towel Dispenser **Block 3047**

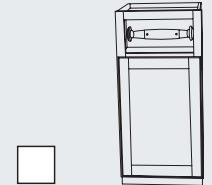

Wall Base Tall with Paper Towel Dispenser **Block 3048**

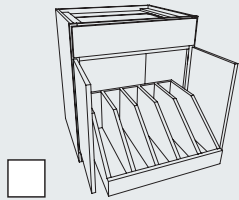

Base with Roll Out Tray Divider **Block 4020**

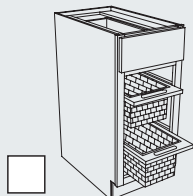

Base with Wicker Basket Storage **Block 4095**

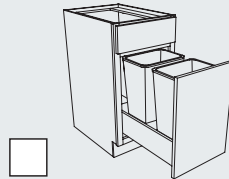

Kitchen Waste Basket **Block 4100**

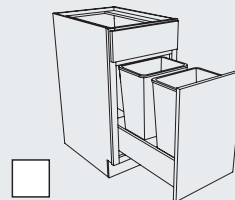

Kitchen Basket with Motion Drive Opening **Block 4106**

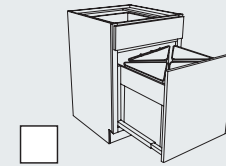

Recycle Base **Block 4130**

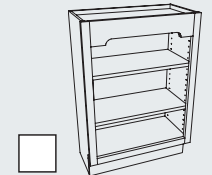

Open Shelf Wall Base **Block 4630**

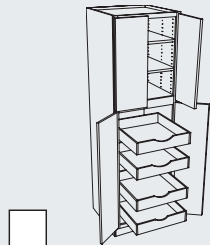

Utility with Roll Out Trays **Block 5150**

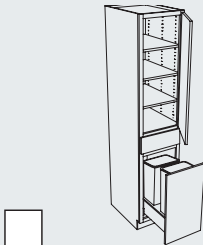

Utility with Waste Bin **Block 5198**

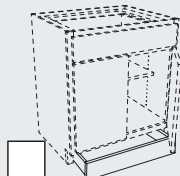

Toe Kick Drawer **Block 9215**

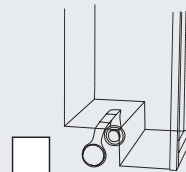

Paper Towel Dispenser Chase Cutout **Block 9165**

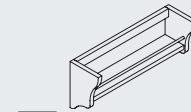

Wall Spice Shelf **Block 10090**

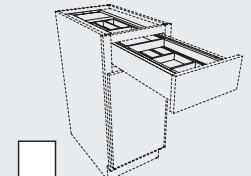

Cutlery Tiered Rack **Block 10200**

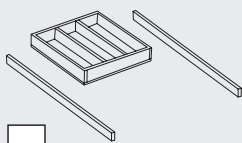

Cutlery Wood Rack **Block 10250**

The Cutlery Wood Rack is a divided box that rests on runners, creating two tiers, so there's more space in the same footprint.

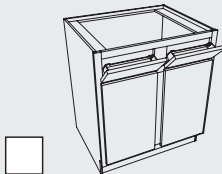

Drawer Front Bins **Block 10270**

Tilt forward bins are a handy place to store keys.

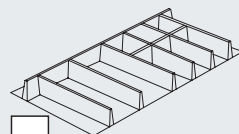

Wood Cutlery Divider **Block 10225**

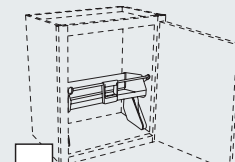

Wall Pull Down Pantry Single Shelf Kit **Block 10321**

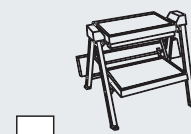

Folding Step **Block 10500**

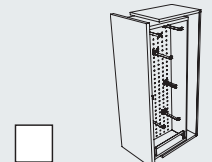

Pull Out Peg Storage **Block 11120**





STARMARK[®]
CABINETS

STARMARK[®] C A B I N E T R Y

600 East 48th Street North • Sioux Falls, SD 57104
www.starmarkcabinetry.com

This brochure is item #1890 and is called the "Organize and Store" brochure.
© 2020 StarMark Cabinetry

-  Before and after transformations posted on
www.facebook.com/starmarkcabinetry
-  www.pinterest.com/starmarkcabinetry/
-  www.youtube.com/user/starmarkcabinetry
-  www.instagram.com/starmarkcabinetry/
-  www.houzz.com/pro/starmarkcabinetry/starmark-cabinetry
-  Send questions to inquiresm@starmarkcabinetry.com
-  Newsletter sign up on www.starmarkcabinetry.com



StarMark Cabinetry is a Norcraft Companies brand.
Norcraft Companies is part of the MasterBrand Cabinets Family.



American Craftsmanship
Manufactured in Sioux Falls, South Dakota
from domestic and global components.



StarMark Cabinetry is CARB II compliant and ESP certified.
Kitchen Cabinet Manufacturers Association
Environmental Stewardship Program
All products impact the environment.
For ESP program criteria, visit kcm.org.

Dealers, this brochure includes these recent product introductions: Optional Walnut Drawer Boxes and Roll Trays, Base Pantry with OXO Storage, Base Plastic Ware Storage, Beverage Pod Tiered Rack, Over Appliance Pull Out and Utility Pull Out Pantry with Soft Close.

This brochure was printed in August 2020.

Accuracy of all reprinted color is subject to printing limitations. Please bear in mind that variation is inherent in wood, and actual finishes may differ substantially from what you see here.

As we continually seek to improve materials and production methods, StarMark Cabinetry reserves the right to change specifications, offerings or designs without notice.

DESIGN CREDITS

BACK COVER, INSIDE BACK COVER This kitchen was designed by Jeff Ptacek, CKD, a designer on staff at StarMark Cabinetry.

